

Precautions Regarding the Use of Product Information or Data in this document

Please check the following details in advance before making use of product information or related data posted on this website. HTK will assume that a customer agreed to following details of Use at the time when customer used this document, so before using it, please be sure to read the following.

■ This document does not guarantee the performance of product, but reference information for initial confirmation use. Specifications and other displayed information may be subject to change without prior notice for product improvement, etc., and product specifications shall be based on officially exchanged specifications documents. When considering or ordering our products, please contact our sales office.

■ While the Company is working to improve quality and reliability, please design safely in preparation for all eventualities. When designing, use products within the range of guarantees such as maximum rated value, operating supply voltage and operating temperature, etc. Please note that the Company shall not be held liable for consequences of the operation of products caused by incorrect or inappropriate use of products posted in this document, such as use exceeding guaranteed values.

■ The products displayed in this document are intended to be used in general electronics equipment (information, communications and audio-visual equipment, measuring instruments, etc.). If you are considering using products in equipment or systems that require special degrees of quality and reliability, and whose failure or malfunction may directly threaten human life or cause bodily harm (such as transportation equipment, safety devices, aviation and space use, nuclear power control or medical equipment including life support equipment), please contact our sales office. Please note that the Company shall not be held liable for damages, etc., caused by such use without prior consultation.

■ The technical information posted in this document is intended to explain the typical operation and application of products, and does not guarantee or grant license to the intellectual property rights or other rights of the Company or any third party when using them.

■ Please note that the Company shall not be held liable for any defects or damages based on the purchase of the Company's products outside of authorized official sales channels, or use of counterfeit products.

■ Export licenses and approvals based on the Foreign Exchange and Foreign Trade Act are required for export of regulated cargo and services, as defined under the Act, among the products listed in this document.

■ The content displayed in this document is subject to change without prior notice. Users will not be contact regarding any changes to data. Please also note that the Company shall not be held liable for any loss of failure caused by the change, deletion or modification of data content.

Uncontrolled

Contact coplanarity
during reflow soldering

TEST REPORT

Product : SD Memory Card Socket

Data No. : AXA2R63361-M-719

Page No. : 1 / 3

Purpose

This test confirm contact coplanarity during reflow soldering. (Reference data)

Sample

SD Memory Card Socket (Applicable to SDIO R-type, reverse type)

Stand-off 1.5mm 【AXA2R63361-M】 (n = 3)

Test condition

Contact coplanarity is measured in measuring instrument (cores).

The distance between the glass surface measurement basis and contact underside is measured.

Reflow number of times: 2 times

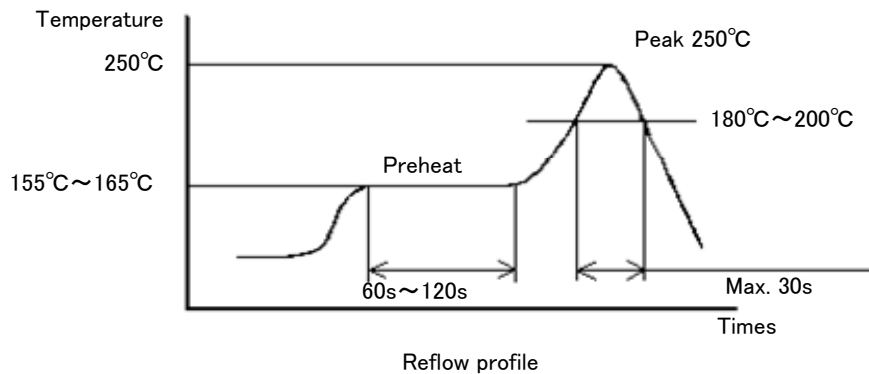

Criteria

Specification: Max. 0.1mm (Initial)

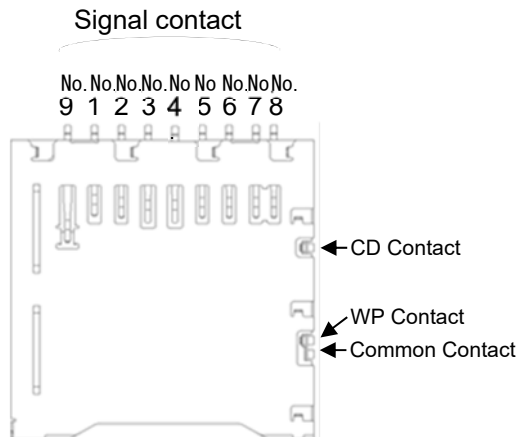

Date: Sep. 19, 2019

HONDA TSUSHIN KOGYO CO., LTD.

Drawn by *T. Sato*

Checked by *S. Yshida*

Checked by _____

Approved by *Y. Kato*

Uncontrolled

Contact coplanarity
during reflow soldering

TEST REPORT

Product : SD Memory Card Socket

Data No. : AXA2R63361-M-719

Page No. : 2 / 3

Test result

• Reflow first time

Sample No. 1

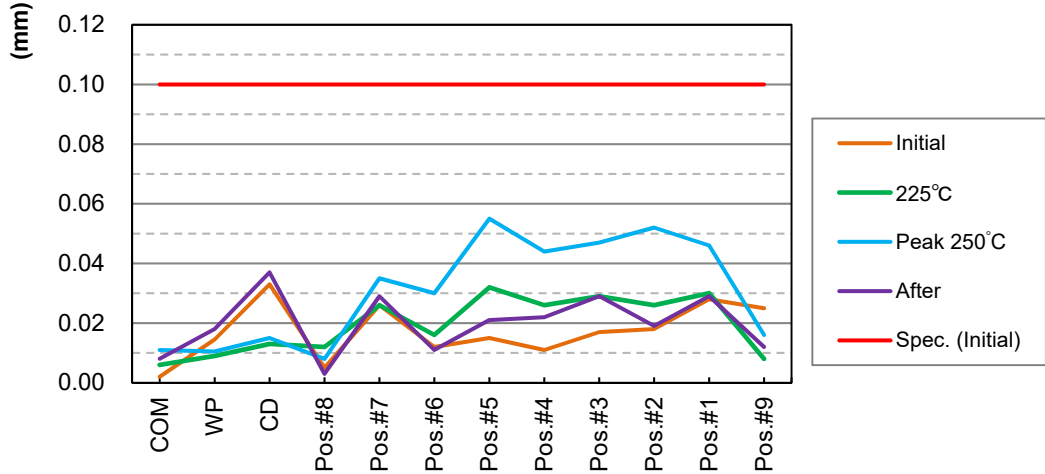

Sample No. 2

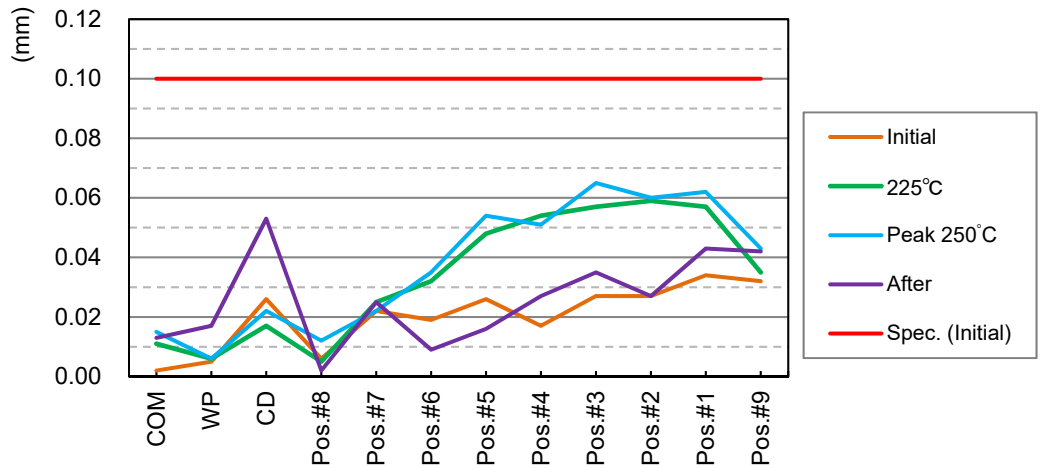

Sample No. 3

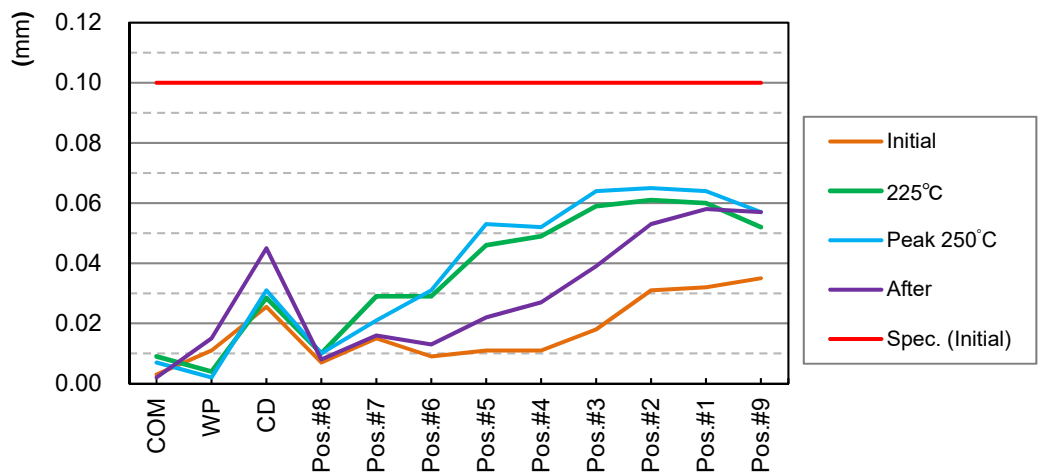

Date: Sep. 19, 2019

HONDA TSUSHIN KOGYO CO., LTD.

Uncontrolled

Contact coplanarity
during reflow soldering

TEST REPORT

Product : SD Memory Card Socket

Data No. : AXA2R63361-M-719

Page No. : 3 / 3

• Reflow second times

Sample No. 1

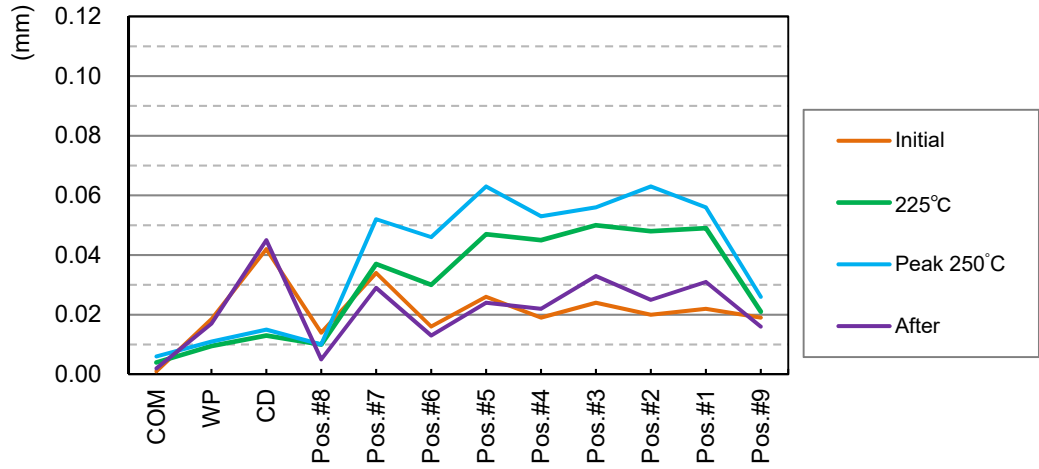

Sample No. 2

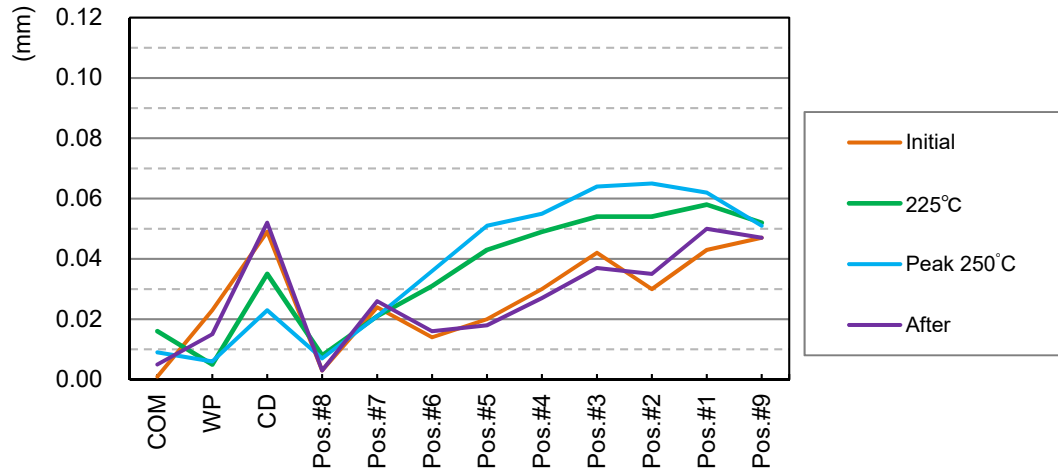

Sample No. 3

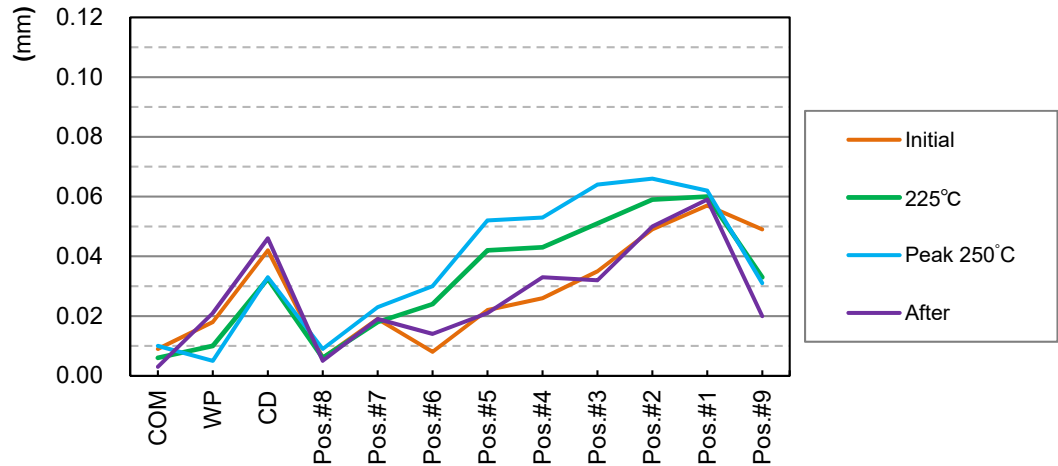

Judgment

No problem.

Date: Sep. 19, 2019

HONDA TSUSHIN KOGYO CO., LTD.