

HKP series

2.54 mm Pitch Connectors

Outline

The HKP series are 2.54 mm pitch connectors for use in equipment where size reduction and high density are required on PCB.

Features

- Provides high reliability and ensures secure contact by adoption of our own unique technologies.
- Provides various types of connectors having from 2 to 72 contacts.
- Allows the economical connection of 3,000 terminals per hour by use of an automatic crimping machine. Also a hand-operated crimping tool can be used for small batches.
- The insulating material is UL-approved.
- Because the contacts can be easily extracted from the insulator with an extraction tool, mis-wiring can be easily corrected.
- FFC or DIC series of connectors can be mated with each other.

Principal Applications

Communications equipment, computers, terminal equipment and automation control equipment

Electrical Characteristics

Rated voltage	300V AC
Rated current	3 A
Insulation resistance	Over 1000 megohms at 500V DC
Dielectric withstanding voltage	1000V AC (r.m.s.)

Document Disclaimer

- When placing orders with us, minimum order quantities are set for every product.
- Be sure to contact us before starting preliminary design of PCBs using our connectors.
- The specifications and information shown in the catalog are subject to change without notice.

Recommended PCB layout

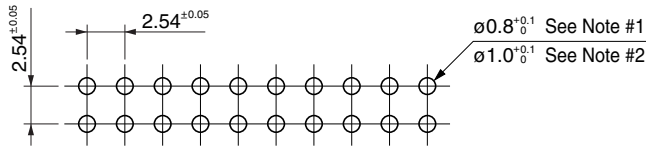

Note 1: Through hole portion of contact:
 0.5×0.5 mm square [HKP-()MV5S+, HKP-()FD2, etc.]

Note 2: Through hole portion of contact:
 0.635×0.635 mm square [HKP-()M5S, etc.]

Dimensions in Combination of Various Connectors are for Reference Purposes

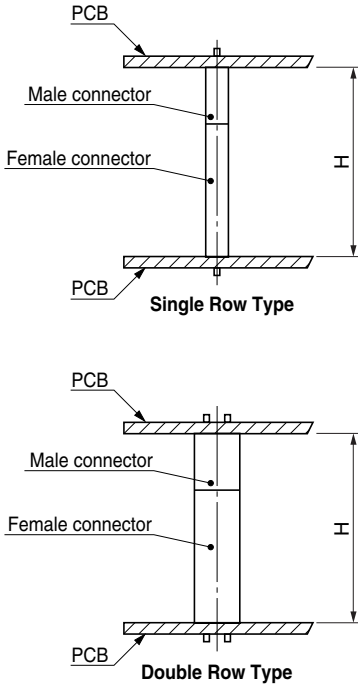

Male connector	Female connector	Type	Dimension between PCBs (H)	No. of contacts
HKP-()M5S	HKP-()FDS2	Single Row	16.9	2 ~ 50
HKP-()MV5S+				
HKP-()M1	HKP-()FD2	Double Row	14.0	4 ~ 70
HKP-()M8				
HKP-()M2				
HKP-()MV2+				
HKP-()M6				
HKP-()M2WT				
HKP-()M29				
HKP-()M1	Z-325-()FD2	Double Row	13.0	4 ~ 50
HKP-()MV2+				
HKP-()M6				
HKP-()M2WT	Z-282-()FD+	Double Row	24.8	4 ~ 36
HKP-()M1				
HKP-()M8				
HKP-()M2				
HKP-()MV2+				
HKP-()M6				
HKP-()M2WT				
HKP-()M29	21.5	4 ~ 70		
HKP-()M29				

Reflow temperature profile (for reference purposes)

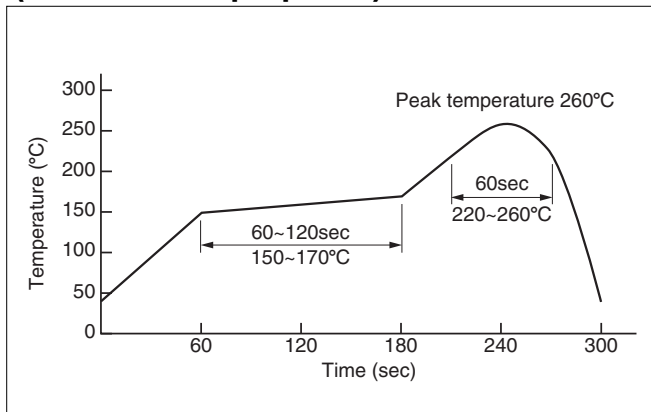

The reflow temperature profile shown in this drawing is for reference purposes. This profile depends on requirements such as reflow equipment, soldering paste, and PCB size. Thus, this profile may not meet with your specific situation. Please evaluate your PCB-mounting soldering and set your own reflow temperature profile.

●Applicable products

HKP-S()MA2LB+
 HKP-S()FD+

The profile shown in this drawing is applicable only for those products shown above.

Flow temperature profile (for reference purposes)

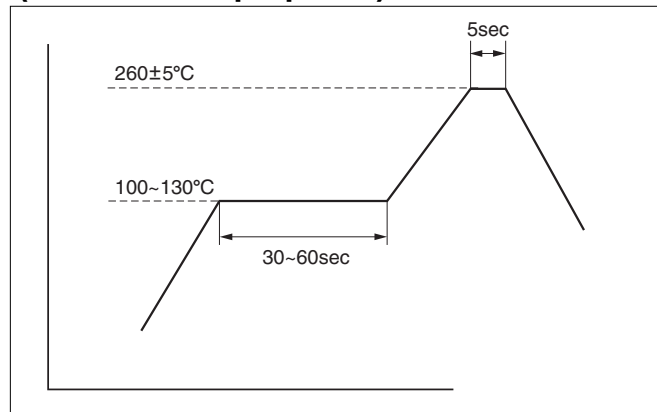

The flow temperature profile as shown above is for reference purposes. This profile depends on requirements such as the PCB size. Thus, this profile may not meet with your specific situation. Please evaluate your PCB-mounting soldering and set your own flow temperature profile.

●Applicable products

HKP series through hole type connector
 HKP-()M4() HKP-()M4()-S2

The profile shown in this drawing is applicable only for those products shown above.

Product List

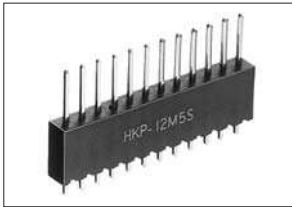

Straight through hole type male connector for PCB
HKP-()M5S
HKP-()MV5S+
D-8
HKP series...6

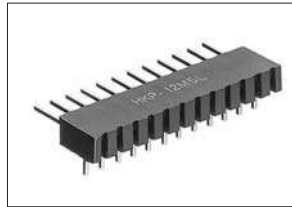

Right-angle through hole type male connector for PCB
HKP-()M5LS
HKP-()MV5LS+
D-9
HKP series...7

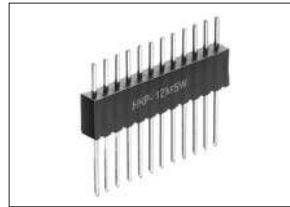

Wire wrapping type male connector for PCB
HKP-()M5WS
D-10
HKP series...8

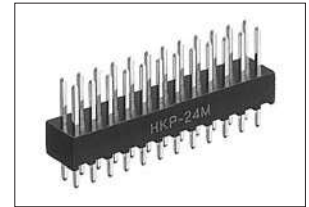

Straight through hole type male connector for PCB
HKP-()M1
D-11
HKP series...9

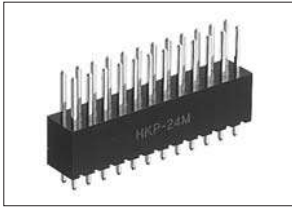

Straight through hole type male connector for PCB
HKP-()M2
HKP-()MV2+
D-12
HKP series...10

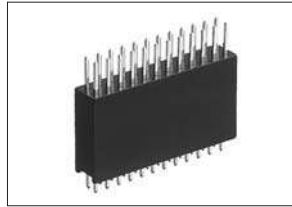

Straight through hole type male connector for PCB
HKP-()M2WT
D-13
HKP series...11



Straight through hole type male connector for PCB
HKP-()M6
D-14
HKP series...12

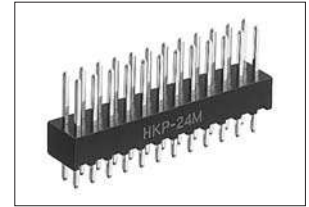

Straight through hole type male connector for PCB
HKP-()M8
D-15
HKP series...13



Straight through hole type male connector for PCB
HKP-()M29
D-16
HKP series...14

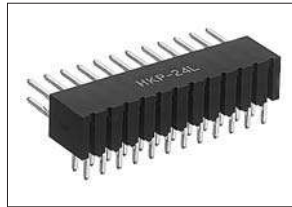

Right-angle through hole type male connector for PCB
HKP-()M2L
HKP-()MV2LG
D-17
HKP series...15

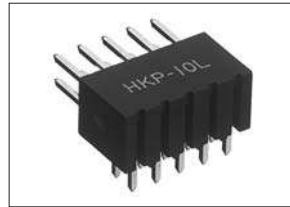

Right-angle through hole type male connector for PCB
HKP-()M6L
D-18
HKP series...16



Wire wrapping type male connector for PCB
HKP-()M2W
D-19
HKP series...17



Male connector for PCB with mounting holes
HKP-()M4()
D-20
HKP series...18



Female insulator for cable with mounting holes
HKP-()F4-1
D-21
HKP series...19



Male connector for PCB with lock screws
HKP-()M4()S2
D-22
HKP series...20



Female insulator for cable with lock screws
HKP-()F4-S1
D-23
HKP series...21



Right-angle SMT type male connector for PCB
HKP-S()MA2LB+
D-24
HKP series...22



Female insulator for crimping
HKP-()FS01
D-25
HKP series...23



Female insulator for crimping
HKP-()F02
D-26
HKP series...24

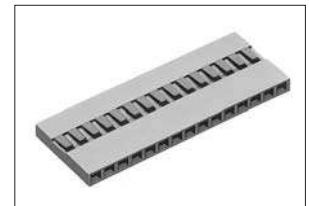

Female insulator for crimping (Miniature HKP series)
HKP-()FSA01
D-27
HKP series...25

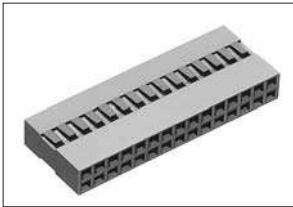

Female insulator for crimping
(Miniature HKP series)
HKP-()FA01

D-28
HKP series...26



Cable crimping type
female contact for cable
HKP-F()()3(A)

D-29
HKP series...27

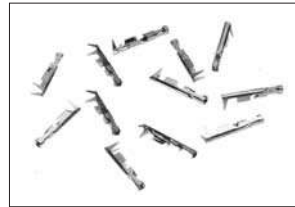

Cable crimping type
female contact for cable
(Miniature HKP series)
HKP-F()()3B

D-30
HKP series...28

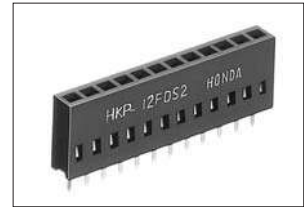

Straight through hole type
female connector for PCB
HKP-()FDS2

D-31
HKP series...29

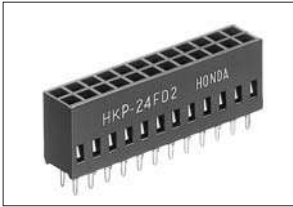

Straight through hole type
female connector for PCB
HKP-()FD2

D-32
HKP series...30

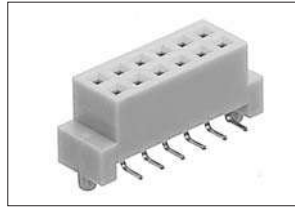

Straight SMT type
female connector for PCB
HKP-S()FD+

D-33
HKP series...31

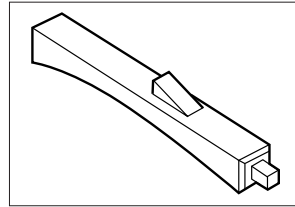

Misinsertion prevention key
for female connectors
HKP-44F201

D-34
HKP series...32

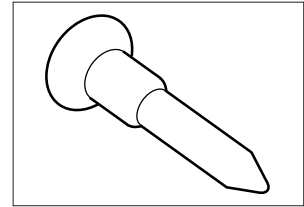

Misinsertion prevention key
for male connectors
GM-25K

D-34
HKP series...32

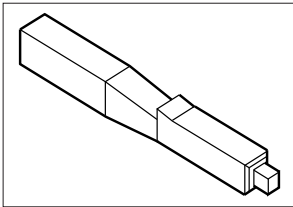

Misinsertion prevention key
for mini-HKP
HKP-72FA02

D-34
HKP series...32

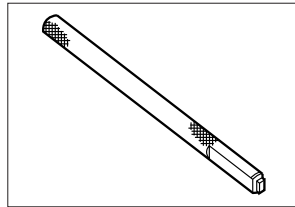

Extraction tool
HKP-KF

D-34
HKP series...32

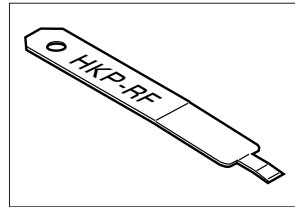

Extraction tool for mini-HKP
HKP-RF

D-34
HKP series...32

Straight through hole type male connector for PCB

HKP-()M5S

HKP-()MV5S+

RoHS

For PCB

Straight Through hole

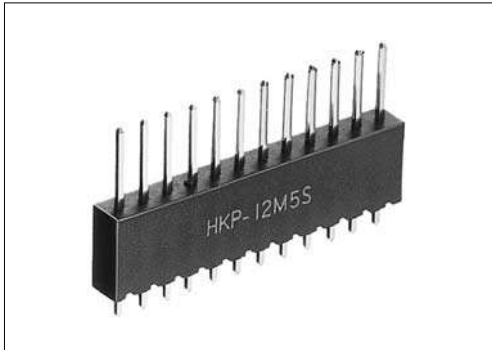

● Configuration of product Part No.

HKP-() M () 5 S ()

① ② ③ ④ ⑤ ⑥

- ① Series name
- ② No. of contacts: 2-50
- ③ Type of contact
M : Male
- ④⑥ Contact plating
Blank : Gold plate
V / + : Gold plate
- ⑤ Contact alignment
S : Single-row type

The value within parentheses indicates the dimension of MV5S+ connectors.

Part No.	A	B
HKP-15M()5S()	35.56	38.70
HKP-16M()5S()	38.10	41.24
HKP-17M()5S()	40.64	43.78
HKP-18M()5S()	43.18	46.32
HKP-19M()5S()	45.72	48.86
HKP-20M()5S()	48.26	51.40
HKP-21M()5S()	50.80	53.94
HKP-22M()5S()	53.34	56.48
HKP-23M()5S()	55.88	59.02
HKP-24M()5S()	58.42	61.56
HKP-25M()5S()	60.96	64.10
HKP-26M()5S()	63.50	66.64
HKP-27M()5S()	66.04	69.18
HKP-28M()5S()	68.58	71.72
HKP-29M()5S()	71.12	74.26
HKP-30M()5S()	73.66	76.80
HKP-31M()5S()	76.20	79.34
HKP-32M()5S()	78.74	81.88
HKP-33M()5S()	81.28	84.42
HKP-34M()5S()	83.82	86.96
HKP-35M()5S()	86.36	89.50
HKP-36M()5S()	88.90	92.04
HKP-37M()5S()	91.44	94.58
HKP-38M()5S()	93.98	97.12
HKP-39M()5S()	96.52	99.66
HKP-40M()5S()	99.06	102.20
HKP-41M()5S()	101.60	104.74
HKP-42M()5S()	104.14	107.28
HKP-43M()5S()	106.68	109.82
HKP-44M()5S()	109.22	112.36
HKP-45M()5S()	111.76	114.90
HKP-46M()5S()	114.30	117.44
HKP-47M()5S()	116.84	119.98
HKP-48M()5S()	119.38	122.52
HKP-49M()5S()	121.92	125.06
HKP-50M()5S()	124.46	127.60

● Dimensions

Part No.	A	B
HKP-2M()5S()	2.54	5.68
HKP-3M()5S()	5.08	8.22
HKP-4M()5S()	7.62	10.76
HKP-5M()5S()	10.16	13.30
HKP-6M()5S()	12.70	15.84
HKP-7M()5S()	15.24	18.38
HKP-8M()5S()	17.78	20.92
HKP-9M()5S()	20.32	23.46
HKP-10M()5S()	22.86	26.00
HKP-11M()5S()	25.40	28.54
HKP-12M()5S()	27.94	31.08
HKP-13M()5S()	30.48	33.62
HKP-14M()5S()	33.02	36.16

● Components

①	Insulator
②	Contact

Mating connectors: HKP series single-row type female connector

DIC series

Right-angle through hole type male connector for PCB

HKP-()M5LS

HKP-()MV5LS+

For PCB

Right-angle Through hole

RoHS

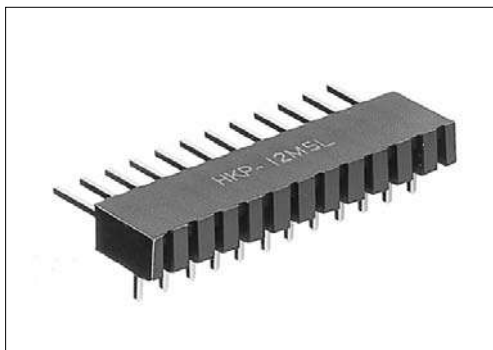

● Configuration of product Part No.

HKP- () M () 5L S ()

- ① Series name
- ② No. of contacts: 2-50
- ③ Type of contact
M : Male
- ④⑦ Contact plating
Blank : Gold plate
V / + : Gold plate
- ⑤ Type of contact
L: Right-angle
- ⑥ Contact alignment
S: Single-row type

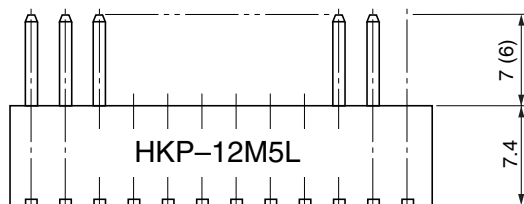
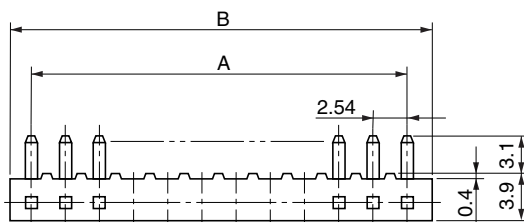

The value within parentheses indicates the dimension of MV5LS+ connectors.

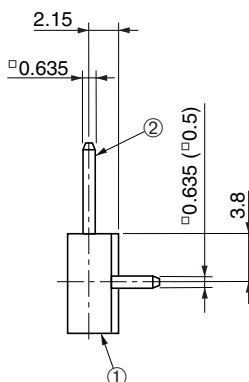

Part No.	A	B
HKP-15M()5LS()	35.56	38.70
HKP-16M()5LS()	38.10	41.24
HKP-17M()5LS()	40.64	43.78
HKP-18M()5LS()	43.18	46.32
HKP-19M()5LS()	45.72	48.86
HKP-20M()5LS()	48.26	51.40
HKP-21M()5LS()	50.80	53.94
HKP-22M()5LS()	53.34	56.48
HKP-23M()5LS()	55.88	59.02
HKP-24M()5LS()	58.42	61.56
HKP-25M()5LS()	60.96	64.10
HKP-26M()5LS()	63.50	66.64
HKP-27M()5LS()	66.04	69.18
HKP-28M()5LS()	68.58	71.72
HKP-29M()5LS()	71.12	74.26
HKP-30M()5LS()	73.66	76.80
HKP-31M()5LS()	76.20	79.34
HKP-32M()5LS()	78.74	81.88
HKP-33M()5LS()	81.28	84.42
HKP-34M()5LS()	83.82	86.96
HKP-35M()5LS()	86.36	89.50
HKP-36M()5LS()	88.90	92.04
HKP-37M()5LS()	91.44	94.58
HKP-38M()5LS()	93.98	97.12
HKP-39M()5LS()	96.52	99.66
HKP-40M()5LS()	99.06	102.20
HKP-41M()5LS()	101.60	104.74
HKP-42M()5LS()	104.14	107.28
HKP-43M()5LS()	106.68	109.82
HKP-44M()5LS()	109.22	112.36
HKP-45M()5LS()	111.76	114.90
HKP-46M()5LS()	114.30	117.44
HKP-47M()5LS()	116.84	119.98
HKP-48M()5LS()	119.38	122.52
HKP-49M()5LS()	121.92	125.06
HKP-50M()5LS()	124.46	127.60

● Dimensions

Part No.	A	B
HKP-2M()5LS()	2.54	5.68
HKP-3M()5LS()	5.08	8.22
HKP-4M()5LS()	7.62	10.76
HKP-5M()5LS()	10.16	13.30
HKP-6M()5LS()	12.70	15.84
HKP-7M()5LS()	15.24	18.38
HKP-8M()5LS()	17.78	20.92
HKP-9M()5LS()	20.32	23.46
HKP-10M()5LS()	22.86	26.00
HKP-11M()5LS()	25.40	28.54
HKP-12M()5LS()	27.94	31.08
HKP-13M()5LS()	30.48	33.62
HKP-14M()5LS()	33.02	36.16

● Components

① Insulator
② Contact

Mating connectors: HKP series single-row type female connector

DIC series

Wire wrapping type male connector for PCB HKP-()M5WS

2.54 mm pitch connector

For PCB

Wire wrapping

RoHS

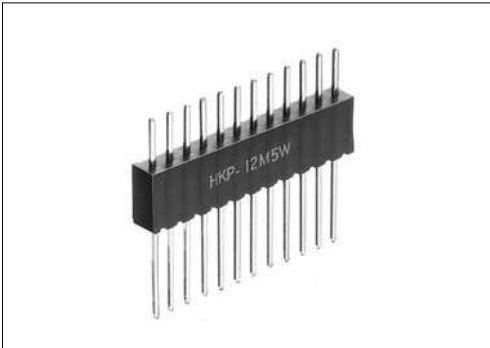

● Configuration of product Part No.

HKP- () M 5W S

① ② ③ ④

- ① Series name
- ② No. of contacts: 2-50
- ③ Type of contact
M5W: Wire wrapping type, male
- ④ Contact alignment
S: Single-row type

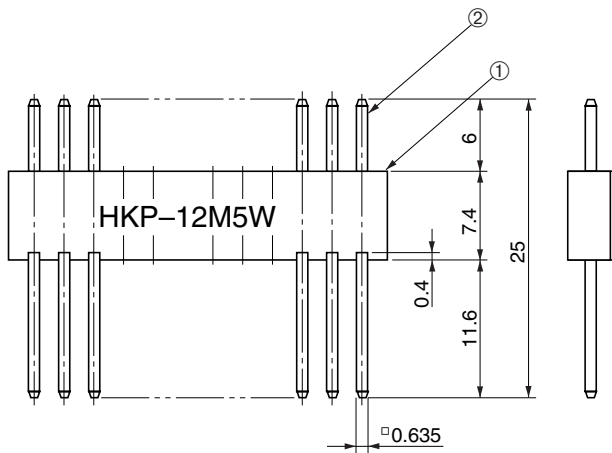
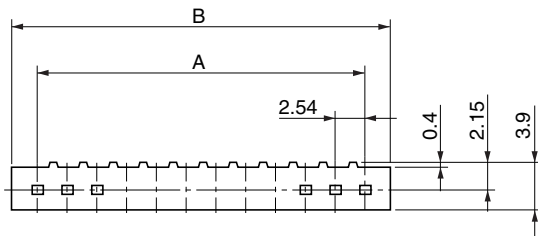

Part No.	A	B
HKP-15M5WS	35.56	38.70
HKP-16M5WS	38.10	41.24
HKP-17M5WS	40.64	43.78
HKP-18M5WS	43.18	46.32
HKP-19M5WS	45.72	48.86
HKP-20M5WS	48.26	51.40
HKP-21M5WS	50.80	53.94
HKP-22M5WS	53.34	56.48
HKP-23M5WS	55.88	59.02
HKP-24M5WS	58.42	61.56
HKP-25M5WS	60.96	64.10
HKP-26M5WS	63.50	66.64
HKP-27M5WS	66.04	69.18
HKP-28M5WS	68.58	71.72
HKP-29M5WS	71.12	74.26
HKP-30M5WS	73.66	76.80
HKP-31M5WS	76.20	79.34
HKP-32M5WS	78.74	81.88
HKP-33M5WS	81.28	84.42
HKP-34M5WS	83.82	86.96
HKP-35M5WS	86.36	89.50
HKP-36M5WS	88.90	92.04
HKP-37M5WS	91.44	94.58
HKP-38M5WS	93.98	97.12
HKP-39M5WS	96.52	99.66
HKP-40M5WS	99.06	102.20
HKP-41M5WS	101.60	104.74
HKP-42M5WS	104.14	107.28
HKP-43M5WS	106.68	109.82
HKP-44M5WS	109.22	112.36
HKP-45M5WS	111.76	114.90
HKP-46M5WS	114.30	117.44
HKP-47M5WS	116.84	119.98
HKP-48M5WS	119.38	122.52
HKP-49M5WS	121.92	125.06
HKP-50M5WS	124.46	127.60

● Dimensions

Part No.	A	B
HKP-2M5WS	2.54	5.68
HKP-3M5WS	5.08	8.22
HKP-4M5WS	7.62	10.76
HKP-5M5WS	10.16	13.30
HKP-6M5WS	12.70	15.84
HKP-7M5WS	15.24	18.38
HKP-8M5WS	17.78	20.92
HKP-9M5WS	20.32	23.46
HKP-10M5WS	22.86	26.00
HKP-11M5WS	25.40	28.54
HKP-12M5WS	27.94	31.08
HKP-13M5WS	30.48	33.62
HKP-14M5WS	33.02	36.16

● Components

①	Insulator
②	Contact

Mating connectors: HKP series single-row type female connector

DIC series

Straight through hole type male connector for PCB
HKP-()M1

For PCB

Straight Through hole

RoHS

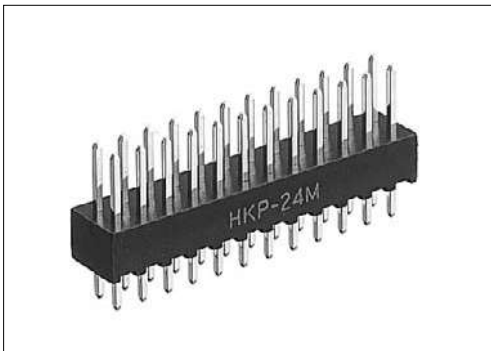

● Configuration of product Part No.

HKP- () M 1

① ② ③

- ① Series name
- ② No. of contacts: 4-70
- ③ Type of contact
M: Male

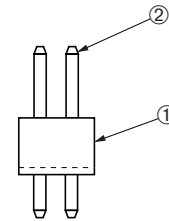
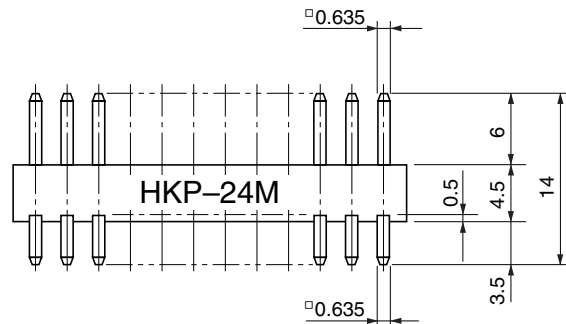
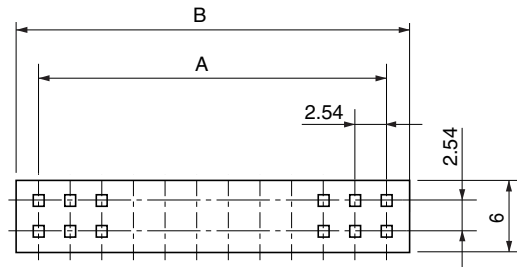

● Dimensions

No. of contacts	A	B	No. of contacts	A	B	No. of contacts	A	B	No. of contacts	A	B
4	2.54	5.68	22	25.40	28.54	40	48.26	51.40	58	71.12	74.26
6	5.08	8.22	24	27.94	31.08	42	50.80	53.94	60	73.66	76.80
8	7.62	10.76	26	30.48	33.62	44	53.34	56.48	62	76.20	79.34
10	10.16	13.30	28	33.02	36.16	46	55.88	59.02	64	78.74	81.88
12	12.70	15.84	30	35.56	38.70	48	58.42	61.56	66	81.28	84.42
14	15.24	18.38	32	38.10	41.24	50	60.96	64.10	68	83.82	86.96
16	17.78	20.92	34	40.64	43.78	52	63.50	66.64	70	86.36	89.50
18	20.32	23.46	36	43.18	46.32	54	66.04	69.18			
20	22.86	26.00	38	45.72	48.86	56	68.58	71.72			

● Components

①	Insulator
②	Contact

Mating connectors: HKP series double-row type female connector

DIC series

Straight through hole type male connector for PCB

HKP-()M2

HKP-()MV2+

For PCB

Straight Through hole

RoHS



● Configuration of product Part No.

HKP- () M () 2 ()

① ② ③ ④ ⑤

- ① Series name
- ② No. of contacts: 4-70
- ③ Type of contact
M: Male
- ④⑤ Contact plating
Blank: Gold plate
V / + : Gold plate

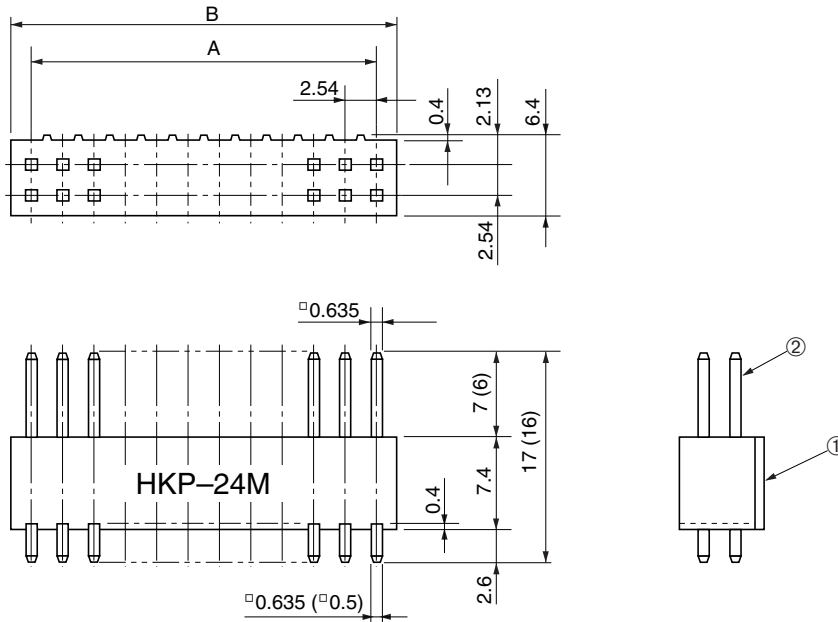

The value within parentheses indicates the dimension of MV2+ connectors.

● Dimensions

No. of contacts	A	B	No. of contacts	A	B	No. of contacts	A	B	No. of contacts	A	B
4	2.54	5.68	22	25.40	28.54	40	48.26	51.40	58	71.12	74.26
6	5.08	8.22	24	27.94	31.08	42	50.80	53.94	60	73.66	76.80
8	7.62	10.76	26	30.48	33.62	44	53.34	56.48	62	76.20	79.34
10	10.16	13.30	28	33.02	36.16	46	55.88	59.02	64	78.74	81.88
12	12.70	15.84	30	35.56	38.70	48	58.42	61.56	66	81.28	84.42
14	15.24	18.38	32	38.10	41.24	50	60.96	64.10	68	83.82	86.96
16	17.78	20.92	34	40.64	43.78	52	63.50	66.64	70	86.36	89.50
18	20.32	23.46	36	43.18	46.32	54	66.04	69.18			
20	22.86	26.00	38	45.72	48.86	56	68.58	71.72			

● Components

①	Insulator
②	Contact

Mating connectors: HKP series double-row type female connector

DIC series

Straight through hole type male connector for PCB
 HKP-()M2WT

For PCB

Straight Through hole

RoHS



● Configuration of product Part No.

HKP- () M2WT

① ② ③

- ① Series name
- ② No. of contacts: 4-36
- ③ Type of contact
M: Male

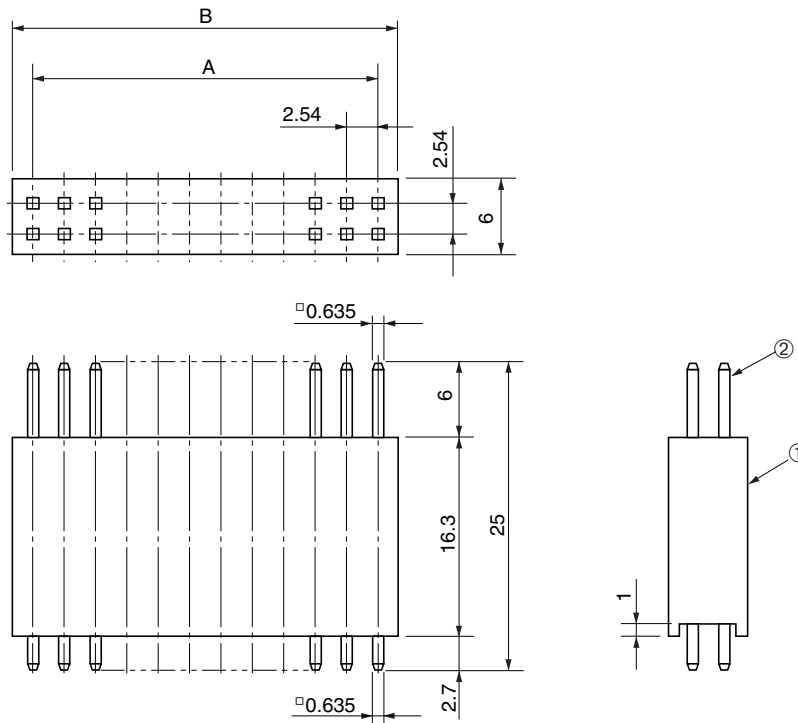

● Dimensions

No. of contacts	A	B	No. of contacts	A	B
4	2.54	5.68	22	25.40	28.54
6	5.08	8.22	24	27.94	31.08
8	7.62	10.76	26	30.48	33.62
10	10.16	13.30	28	33.02	36.16
12	12.70	15.84	30	35.56	38.70
14	15.24	18.38	32	38.10	41.24
16	17.78	20.92	34	40.64	43.78
18	20.32	23.46	36	43.18	46.32
20	22.86	26.00	38	45.72	48.86

● Components

①	Insulator
②	Contact

Mating connectors: HKP series double-row type female connector

DIC series

Straight through hole type male connector for PCB
HKP-()M()6

For PCB

Straight Through hole

RoHS

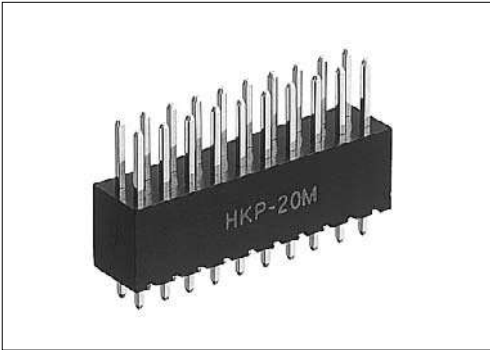

● Configuration of product Part No.

HKP- () M6

① ② ③

- ① Series name
- ② No. of contacts: 4-70
- ③ Type of contact
M: Male

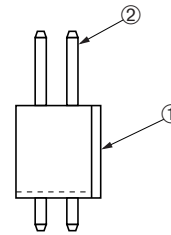
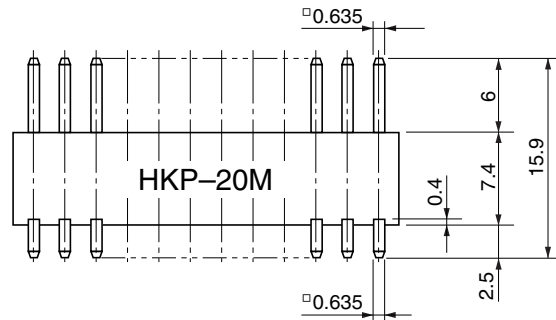
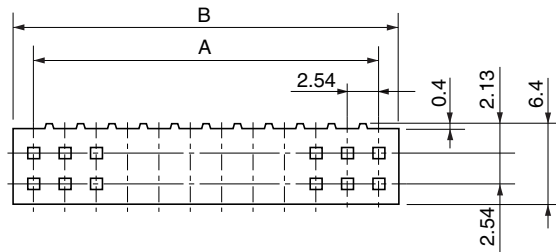

● Dimensions

No. of contacts	A	B	No. of contacts	A	B	No. of contacts	A	B	No. of contacts	A	B
4	2.54	5.68	22	25.40	28.54	40	48.26	51.40	58	71.12	74.26
6	5.08	8.22	24	27.94	31.08	42	50.80	53.94	60	73.66	76.80
8	7.62	10.76	26	30.48	33.62	44	53.34	56.48	62	76.20	79.34
10	10.16	13.30	28	33.02	36.16	46	55.88	59.02	64	78.74	81.88
12	12.70	15.84	30	35.56	38.70	48	58.42	61.56	66	81.28	84.42
14	15.24	18.38	32	38.10	41.24	50	60.96	64.10	68	83.82	86.96
16	17.78	20.92	34	40.64	43.78	52	63.50	66.64	70	86.36	89.50
18	20.32	23.46	36	43.18	46.32	54	66.04	69.18			
20	22.86	26.00	38	45.72	48.86	56	68.58	71.72			

● Components

①	Insulator
②	Contact

Mating connectors: HKP series double-row type female connector

DIC series

Straight through hole type male connector for PCB HKP-()M8

2.54 mm pitch connector

For PCB

Straight Through hole

RoHS



● Configuration of product Part No.

HKP- () M8

① ② ③

- ① Series name
- ② No. of contacts: 4-70
- ③ Type of contact
M: Male

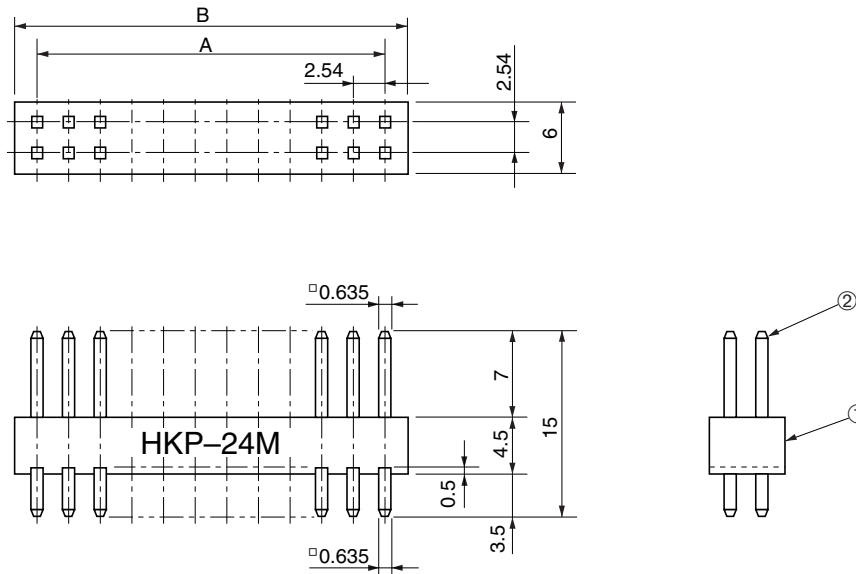

● Dimensions

No. of contacts	A	B	No. of contacts	A	B	No. of contacts	A	B	No. of contacts	A	B
4	2.54	5.68	22	25.40	28.54	40	48.26	51.40	58	71.12	74.26
6	5.08	8.22	24	27.94	31.08	42	50.80	53.94	60	73.66	76.80
8	7.62	10.76	26	30.48	33.62	44	53.34	56.48	62	76.20	79.34
10	10.16	13.30	28	33.02	36.16	46	55.88	59.02	64	78.74	81.88
12	12.70	15.84	30	35.56	38.70	48	58.42	61.56	66	81.28	84.42
14	15.24	18.38	32	38.10	41.24	50	60.96	64.10	68	83.82	86.96
16	17.78	20.92	34	40.64	43.78	52	63.50	66.64	70	86.36	89.50
18	20.32	23.46	36	43.18	46.32	54	66.04	69.18			
20	22.86	26.00	38	45.72	48.86	56	68.58	71.72			

● Components

①	Insulator
②	Contact

Mating connectors: HKP series double-row type female connector

DIC series

Straight through hole type male connector for PCB
HKP-()M29

For PCB

Straight Through hole

RoHS



● Configuration of product Part No.

HKP- () M29

① ② ③

- ① Series name
- ② No. of contacts: 4-70
- ③ Type of contact
M: Male

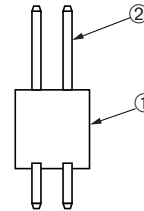
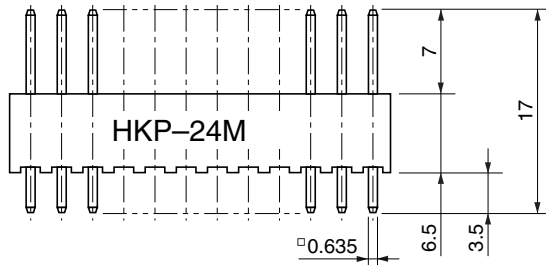
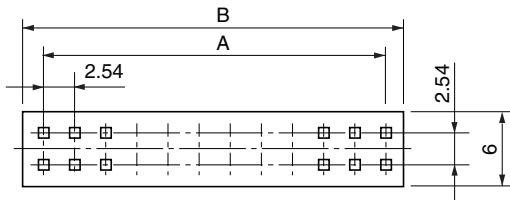

● Dimensions

No. of contacts	A	B	No. of contacts	A	B	No. of contacts	A	B	No. of contacts	A	B
4	2.54	5.68	22	25.40	28.54	40	48.26	51.40	58	71.12	74.26
6	5.08	8.22	24	27.94	31.08	42	50.80	53.94	60	73.66	76.80
8	7.62	10.76	26	30.48	33.62	44	53.34	56.48	62	76.20	79.34
10	10.16	13.30	28	33.02	36.16	46	55.88	59.02	64	78.74	81.88
12	12.70	15.84	30	35.56	38.70	48	58.42	61.56	66	81.28	84.42
14	15.24	18.38	32	38.10	41.24	50	60.96	64.10	68	83.82	86.96
16	17.78	20.92	34	40.64	43.78	52	63.50	66.64	70	86.36	89.50
18	20.32	23.46	36	43.18	46.32	54	66.04	69.18			
20	22.86	26.00	38	45.72	48.86	56	68.58	71.72			

● Components

①	Insulator
②	Contact

Mating connectors: HKP series double-row type female connector

DIC series

Right-angle through hole type male connector for PCB

HKP-()M2L

HKP-()MV2LG

For PCB

Right-angle Through hole

RoHS

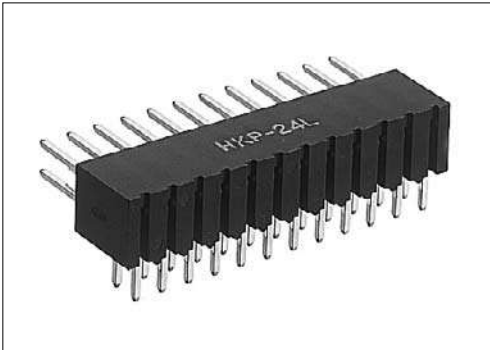

● Configuration of product Part No.

HKP- () M () 2 L ()

① ② ③ ④ ⑤ ⑥

- ① Series name
- ② No. of contacts: 4-70
- ③ Type of contact
M: Male
- ④⑥ Contact plating
Blank: Gold plate
V / G : Gold plate
- ⑤ Type of contact
L: Right-angle

● Dimensions

No. of contacts	A	B
4	2.54	5.68
6	5.08	8.22
8	7.62	10.76
10	10.16	13.30
12	12.70	15.84
14	15.24	18.38
16	17.78	20.92
18	20.32	23.46
20	22.86	26.00
22	25.40	28.54
24	27.94	31.08
26	30.48	33.62
28	33.02	36.16
30	35.56	38.70
32	38.10	41.24
34	40.64	43.78
36	43.18	46.32
38	45.72	48.86
40	48.26	51.40
42	50.80	53.94
44	53.34	56.48
46	55.88	59.02
48	58.42	61.56
50	60.96	64.10
52	63.50	66.64
54	66.04	69.18
56	68.58	71.72
58	71.12	74.26
60	73.66	76.80
62	76.20	79.34
64	78.74	81.88
66	81.28	84.42
68	83.82	86.96
70	86.36	89.50

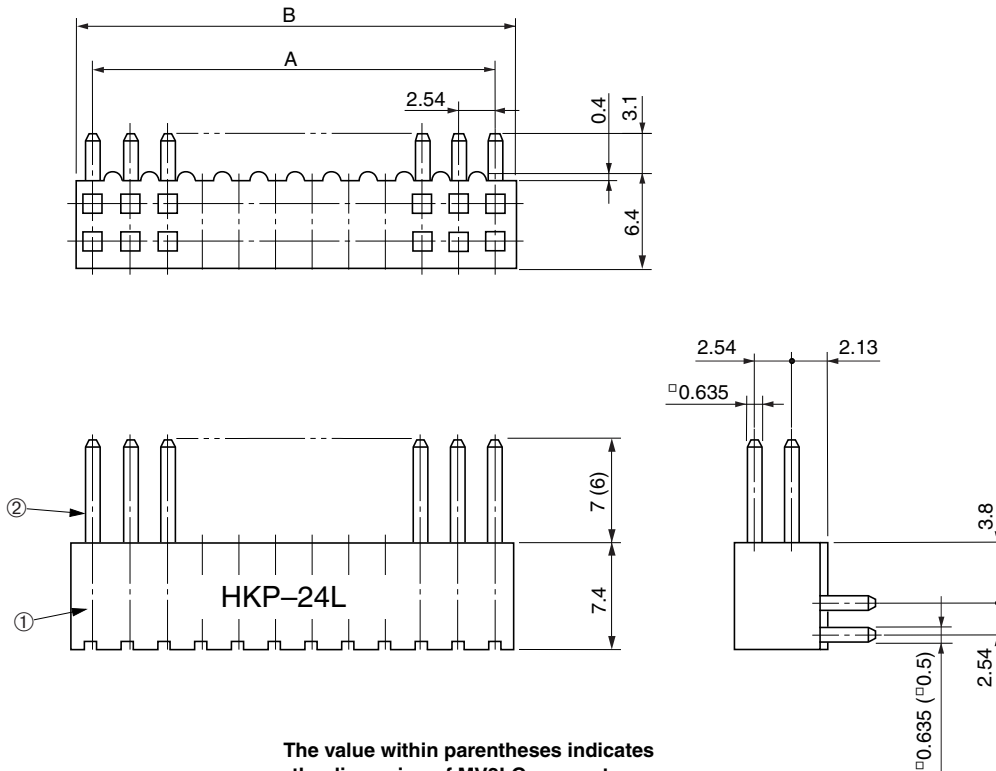

The value within parentheses indicates the dimension of MV2LG connectors.

● Components

①	Insulator
②	Contact

Mating connectors: HKP series double-row type female connector

DIC series

Right-angle through hole type male connector for PCB
 HKP-()M6L

For PCB

Right-angle Through hole

RoHS



● Configuration of product Part No.

HKP- () M6L

① ② ③

- ① Series name
- ② No. of contacts: 4-70
- ③ Type of contact
 M6L: Right-angle type, male

● Dimensions

No. of contacts	A	B
4	2.54	5.68
6	5.08	8.22
8	7.62	10.76
10	10.16	13.30
12	12.70	15.84
14	15.24	18.38
16	17.78	20.92
18	20.32	23.46
20	22.86	26.00
22	25.40	28.54
24	27.94	31.08
26	30.48	33.62
28	33.02	36.16
30	35.56	38.70
32	38.10	41.24
34	40.64	43.78
36	43.18	46.32
38	45.72	48.86
40	48.26	51.40
42	50.80	53.94
44	53.34	56.48
46	55.88	59.02
48	58.42	61.56
50	60.96	64.10
52	63.50	66.64
54	66.04	69.18
56	68.58	71.72
58	71.12	74.26
60	73.66	76.80
62	76.20	79.34
64	78.74	81.88
66	81.28	84.42
68	83.82	86.96
70	86.36	89.50

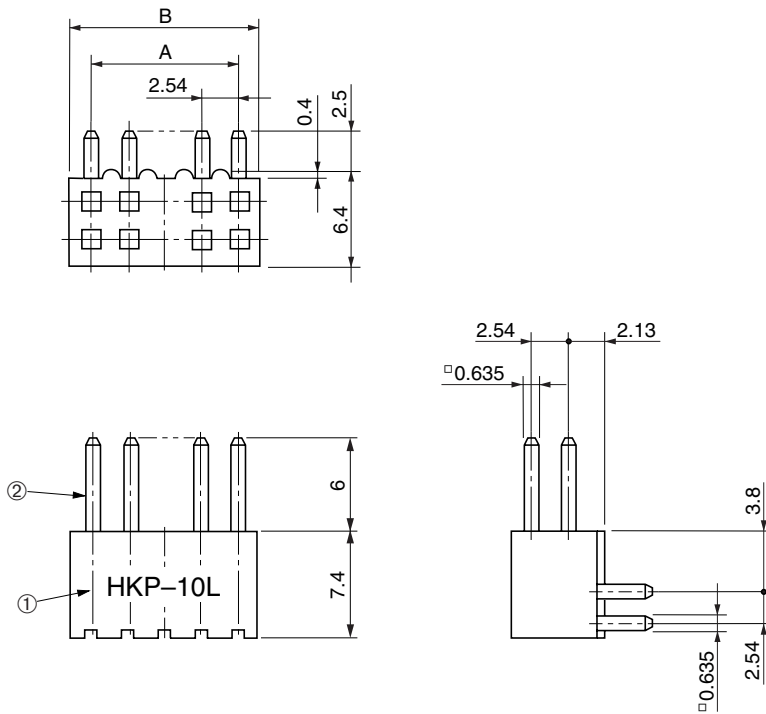

● Components

①	Insulator
②	Contact

Mating connectors: HKP series double-row type female connector

DIC series

Wire wrapping type male connector for PCB HKP-()M2W

2.54 mm pitch connector

For PCB

Wire wrapping

RoHS



● Configuration of product Part No.

HKP- () M 2W

① ② ③

- ① Series name
- ② No. of contacts: 4–70
- ③ Type of contact
M2W: Wire wrapping type, male

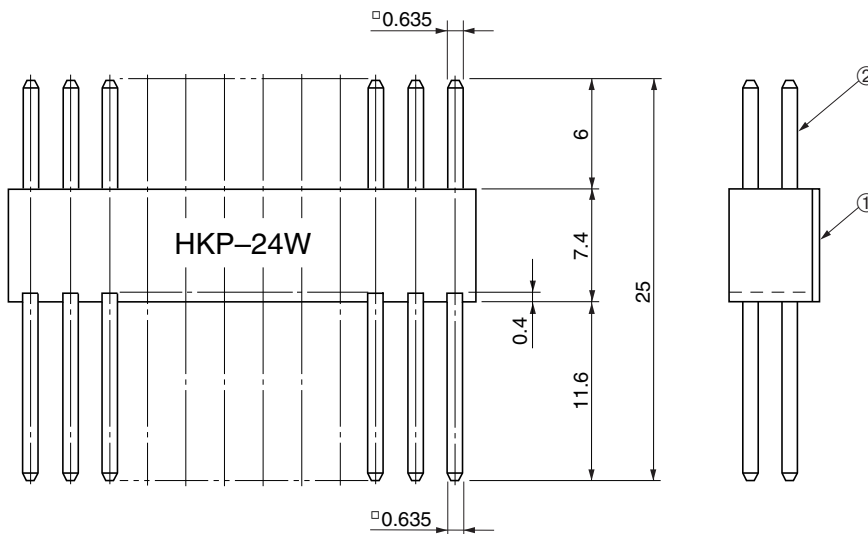
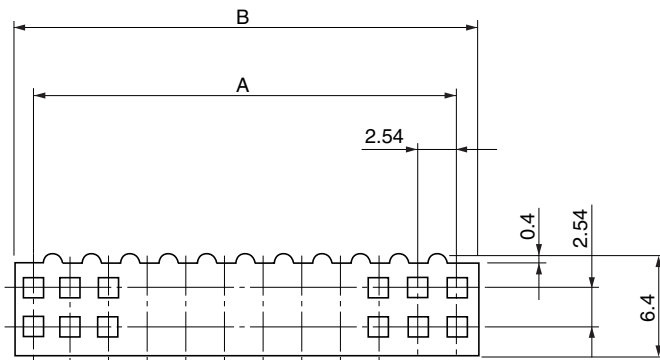

● Dimensions

Part No.	A	B
HKP-4M2W	2.54	5.68
HKP-6M2W	5.08	8.22
HKP-8M2W	7.62	10.76
HKP-10M2W	10.16	13.30
HKP-12M2W	12.70	15.84
HKP-14M2W	15.24	18.38
HKP-16M2W	17.78	20.92
HKP-18M2W	20.32	23.46
HKP-20M2W	22.86	26.00
HKP-22M2W	25.40	28.54
HKP-24M2W	27.94	31.08
HKP-26M2W	30.48	33.62
HKP-28M2W	33.02	36.16
HKP-30M2W	35.56	38.70
HKP-32M2W	38.10	41.24
HKP-34M2W	40.64	43.78
HKP-36M2W	43.18	46.32
HKP-38M2W	45.72	48.86
HKP-40M2W	48.26	51.40
HKP-42M2W	50.80	53.94
HKP-44M2W	53.34	56.48
HKP-46M2W	55.88	59.02
HKP-48M2W	58.42	61.56
HKP-50M2W	60.96	64.10
HKP-52M2W	63.50	66.64
HKP-54M2W	66.04	69.18
HKP-56M2W	68.58	71.72
HKP-58M2W	71.12	74.26
HKP-60M2W	73.66	76.80
HKP-62M2W	76.20	79.34
HKP-64M2W	78.74	81.88
HKP-66M2W	81.28	84.42
HKP-68M2W	83.82	86.96
HKP-70M2W	86.36	89.50

● Components

①	Insulator
②	Contact

Mating connectors: HKP series double-row type female connector

Male connector for PCB with mounting holes
 HKP-()M4()

For PCB

With mounting holes

RoHS

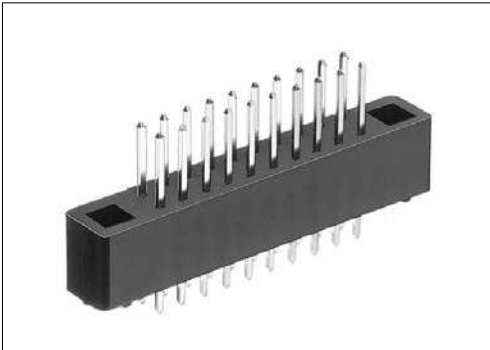

● Configuration of product Part No.

HKP-() M4()

① ② ③

- ① Series name
- ② No. of contacts: 10, 20, 30, 40, or 50
- ③ Type of contact
 - M4 : Straight type male, with mounting holes
 - M4L : Right-angle type male, with mounting holes
 - M4W: Wire wrapping type male, with mounting holes

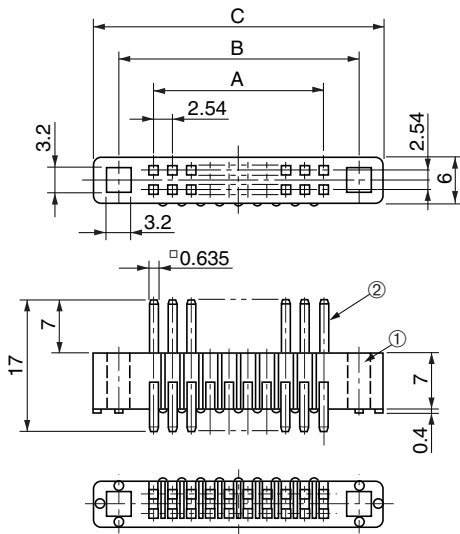

Straight type
 HKP-()M4

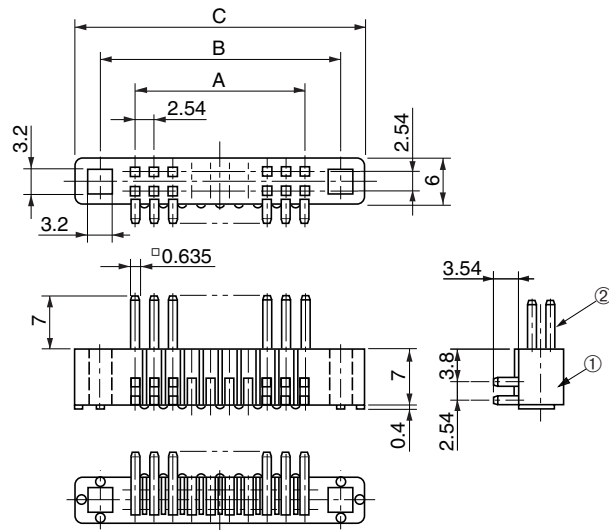

Right-angle type
 HKP-()M4L

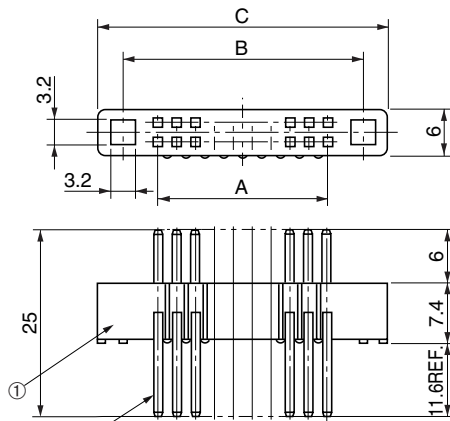

Wire wrapping type
 HKP-()M4W

● Components

①	Insulator
②	Contact

● Dimensions

No. of contacts	A	B	C
10	10.16	19.30	25.30
20	22.86	32.00	38.00
30	35.56	44.70	50.70
40	48.26	57.40	63.40
50	60.96	69.50	75.50

Mating connectors: HKP-()F4-1

Female insulator for cable with mounting holes
HKP-()F4-1

For cable

Crimping

With mounting holes

RoHS

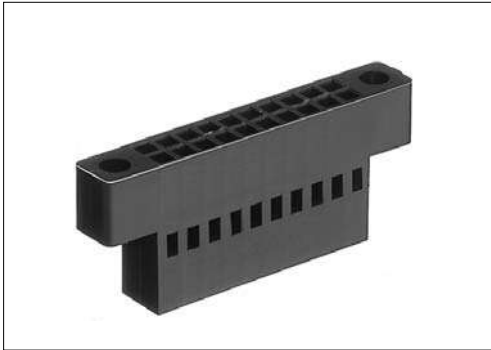

● Configuration of product Part No.

HKP- () F4-1

① ② ③

- ① Series name
- ② No. of contacts: 10, 20, 30, 40, or 50
- ③ Type of insulator
F4-1: Female insulator, with mounting holes

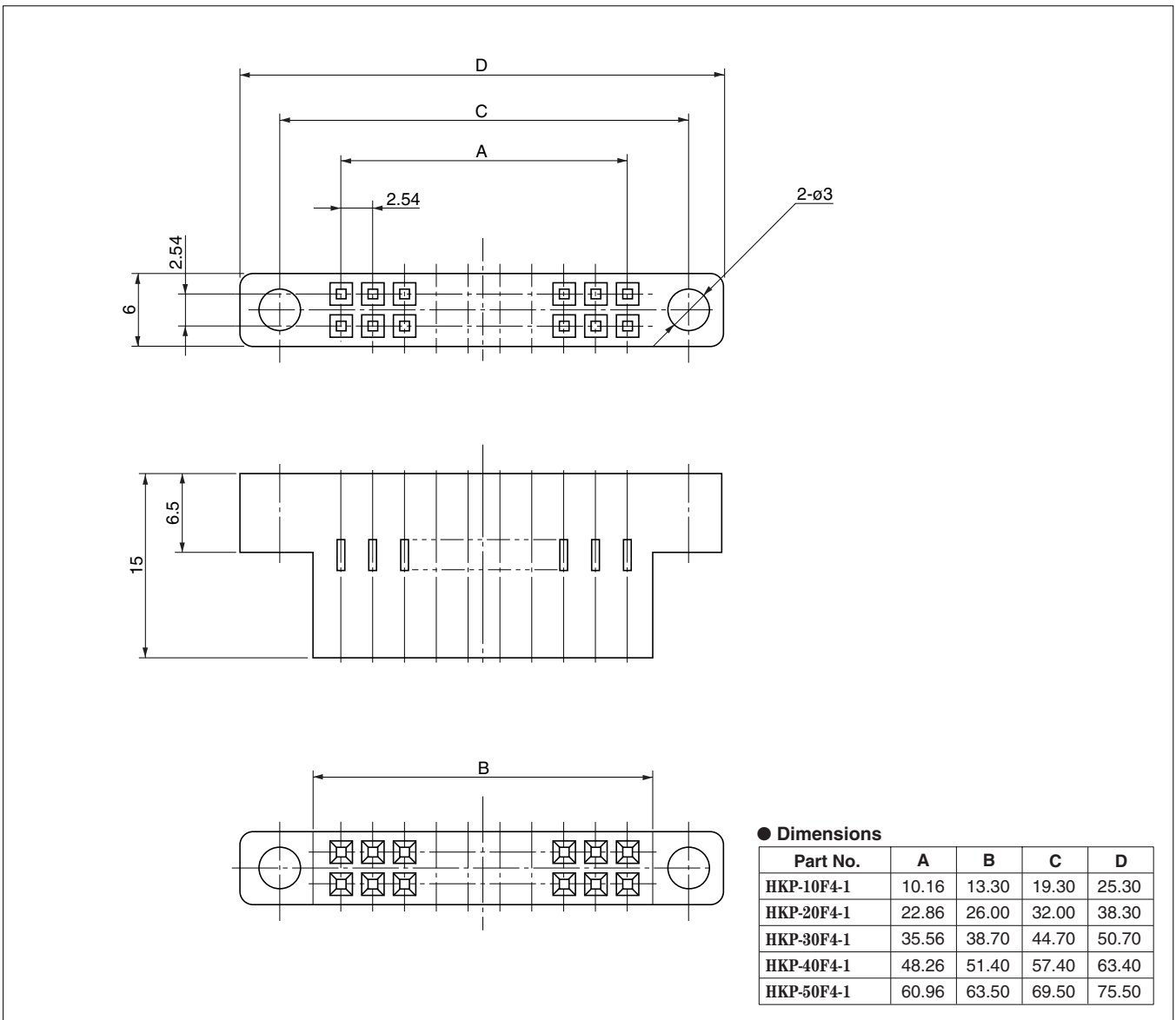

Mating connectors: HKP-()M4()

For use with contacts: HKP series contacts (HKP-F1@3, HKP-F4@3, HKP-F2@3A, HKP-F3@3A)

Male connector for PCB with lock screws
 HKP-()M4()-S2

For PCB

With lock screws

RoHS



● Configuration of product Part No.

HKP- () M4 ()- S2

① ② ③ ④

- ① Series name
- ② No. of contacts: 10, 20, 30, 40, or 50
- ③ Type of contact
 - M4 : Straight type male, with mounting holes
 - M4L : Right-angle type male, with mounting holes
 - M4W: Wire wrapping type male, with mounting holes
- ④ S2: Lock screws

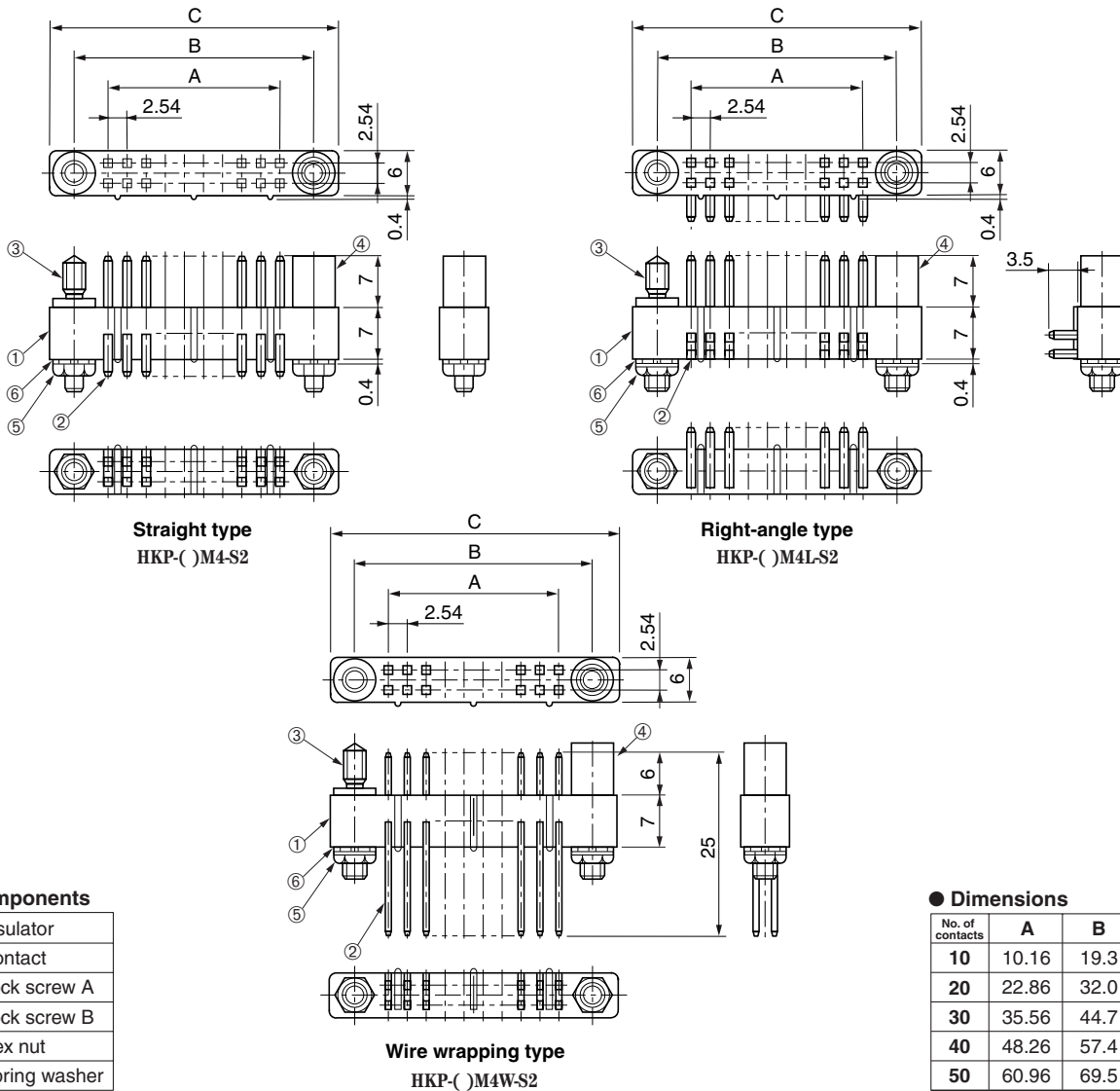

● Components

①	Insulator
②	Contact
③	Lock screw A
④	Lock screw B
⑤	Hex nut
⑥	Spring washer

● Dimensions

No. of contacts	A	B	C
10	10.16	19.3	25.3
20	22.86	32.0	38.0
30	35.56	44.7	50.7
40	48.26	57.4	63.4
50	60.96	69.5	75.5

Mating connectors: HKP-()F4-S1

Female insulator for cable with lock screws

For cable

HKP-()F4-S1

Crimping

RoHS

With lock screws



● Configuration of product Part No.

HKP- () F4- S1

① ② ③

- ① Series name
- ② No. of contacts: 10, 20, 30, 40, or 50
- ③ Type of insulator
F4-S1: Female insulator, with lock screws

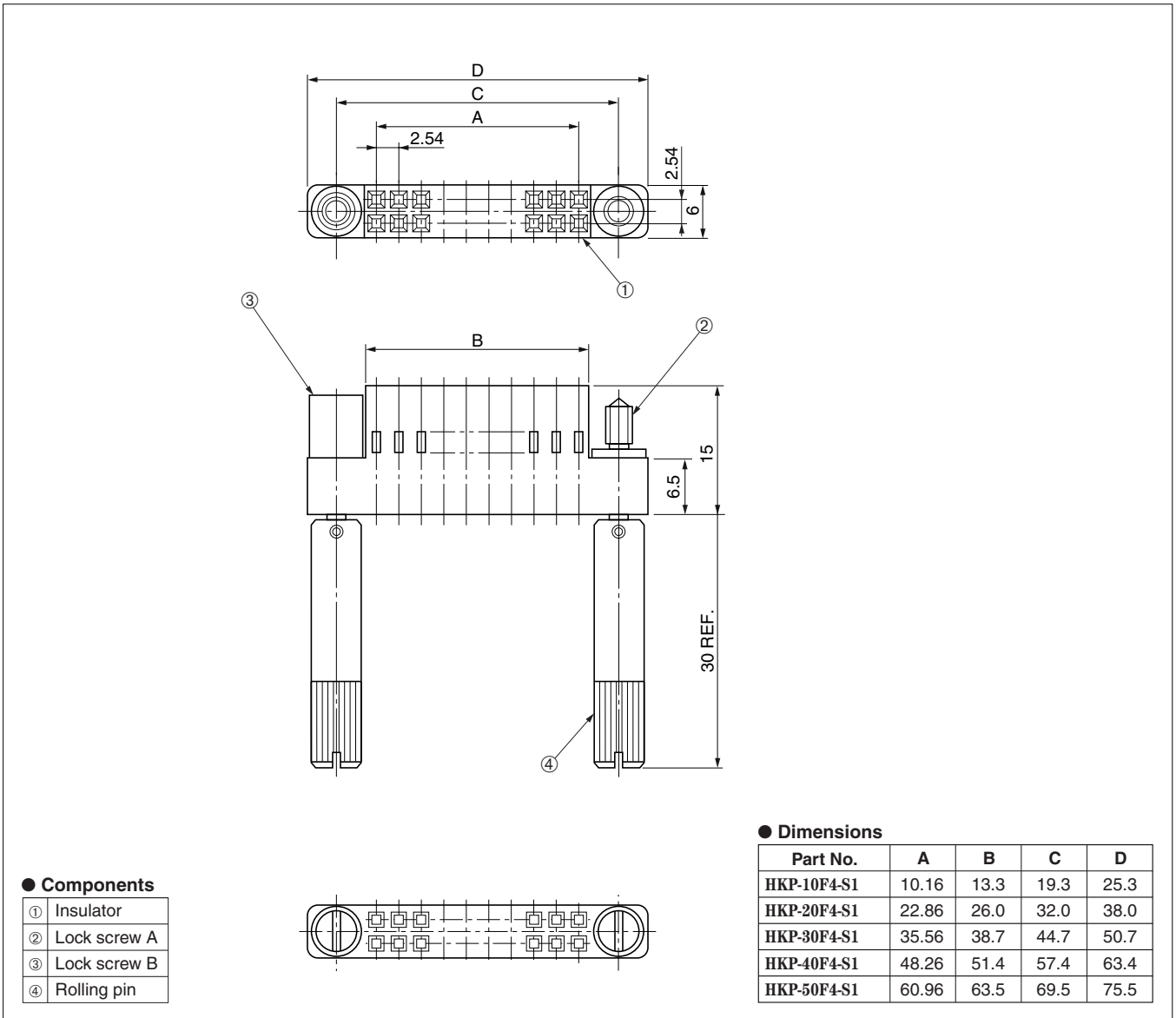

Mating connectors: HKP-()M4()-S2

For use with contacts: HKP series contacts (HKP-F1@3, HKP-F4@3, HKP-F2@3A, HKP-F3@3A)

Right-angle SMT type male connector for PCB
 HKP-S()MA2LB+

For PCB

SMT

RoHS

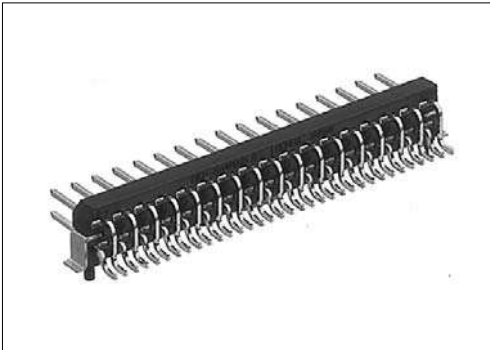

● Configuration of product Part No.

HKP- S() MA2 L B+

① ② ③ ④

- ① Series name
- ② S: SMT type
- ③ No. of contacts: 10, 26 or 34
- ④ Type of contact
 MA2LB: Right-angle, male

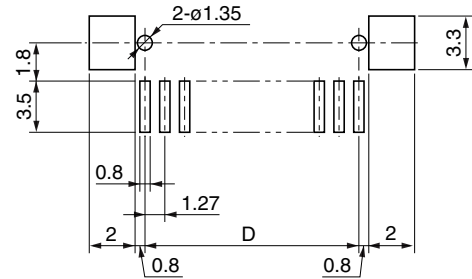
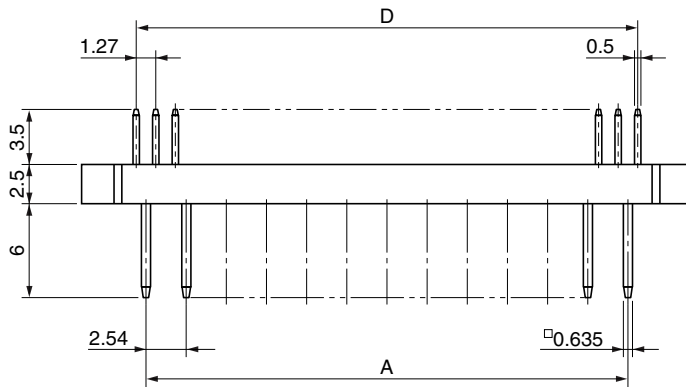

Recommended PCB layout

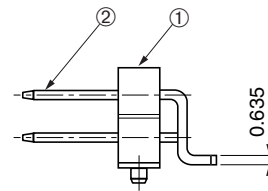
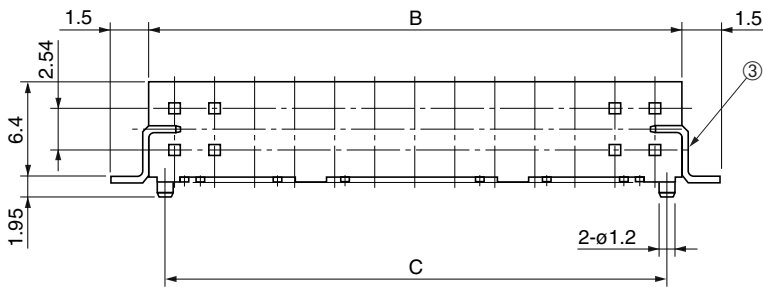

● Components

①	Insulator
②	Contact
③	Hold down

● Dimensions

Part No.	A	B	C	D
HKP-S10MA2LB+	10.16	13.30	11.43	11.43
HKP-S26MA2LB+	30.48	33.62	31.75	31.75
HKP-S34MA2LB+	40.64	43.78	41.91	41.91

Mating connectors: HKP series double-row type female connector

DIC series

Female insulator for crimping HKP-()FS01

2.54 mm pitch connector

For PCB

Crimping

RoHS



● Configuration of product Part No.

HKP- () F S01

① ② ③ ④

- ① Series name
- ② No. of contacts: 2–50
- ③ Type of insulator
F: Femal
- ④ Alignment of contacts to be inserted
S: Single-row type

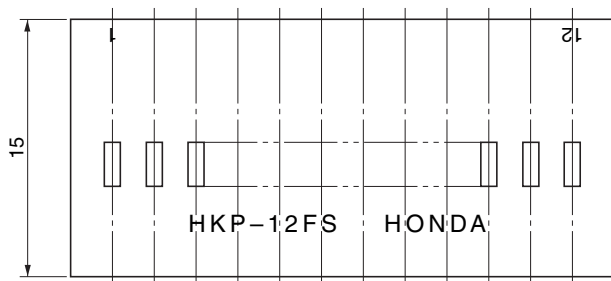
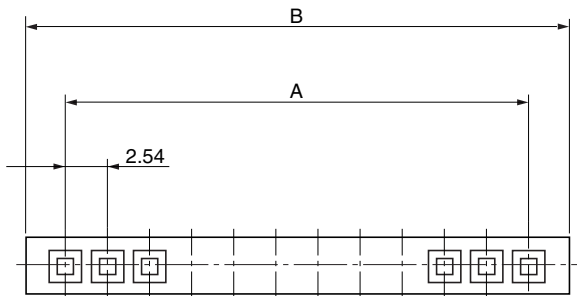

● Dimensions

Part No.	A	B
HKP-2FS01	2.54	5.68
HKP-3FS01	5.08	8.22
HKP-4FS01	7.62	10.76
HKP-5FS01	10.16	13.30
HKP-6FS01	12.70	15.84
HKP-7FS01	15.24	18.38
HKP-8FS01	17.78	20.92
HKP-9FS01	20.32	23.46
HKP-10FS01	22.86	26.0
HKP-11FS01	25.40	28.54
HKP-12FS01	27.94	31.08
HKP-13FS01	30.48	33.62
HKP-14FS01	33.02	36.16
HKP-15FS01	35.56	38.70
HKP-16FS01	38.10	41.24
HKP-17FS01	40.64	43.78
HKP-18FS01	43.18	46.32
HKP-19FS01	45.72	48.86
HKP-20FS01	48.26	51.40
HKP-21FS01	50.80	53.94
HKP-22FS01	53.34	56.48
HKP-23FS01	55.88	59.02
HKP-24FS01	58.42	61.56
HKP-25FS01	60.96	64.10
HKP-26FS01	63.50	66.64

Part No.	A	B
HKP-27FS01	66.04	69.18
HKP-28FS01	68.58	71.72
HKP-29FS01	71.12	74.26
HKP-30FS01	73.66	76.80
HKP-31FS01	76.20	79.34
HKP-32FS01	78.74	81.88
HKP-33FS01	81.28	84.42
HKP-34FS01	83.82	86.96
HKP-35FS01	86.36	89.50
HKP-36FS01	88.90	92.04
HKP-37FS01	91.44	94.58
HKP-38FS01	93.98	97.12
HKP-39FS01	96.52	99.66
HKP-40FS01	99.06	102.2
HKP-41FS01	101.60	104.74
HKP-42FS01	104.14	107.28
HKP-43FS01	106.68	109.82
HKP-44FS01	109.22	112.36
HKP-45FS01	111.76	114.90
HKP-46FS01	114.30	117.44
HKP-47FS01	116.84	119.98
HKP-48FS01	119.38	122.52
HKP-49FS01	121.92	125.06
HKP-50FS01	124.46	127.60

Mating connectors: HKP or FFC series single-row type male connector

For use with contacts: HKP series contacts (HKP-F1@3, HKP-F4@3, HKP-F2@3A, HKP-F3@3A)

Female insulator for crimping
HKP-()F02

For PCB

Crimping

RoHS



● Configuration of product Part No.

HKP-() F02

① ② ③

- ① Series name
- ② No. of contacts: 4-70
- ③ Type of insulator
F: Female

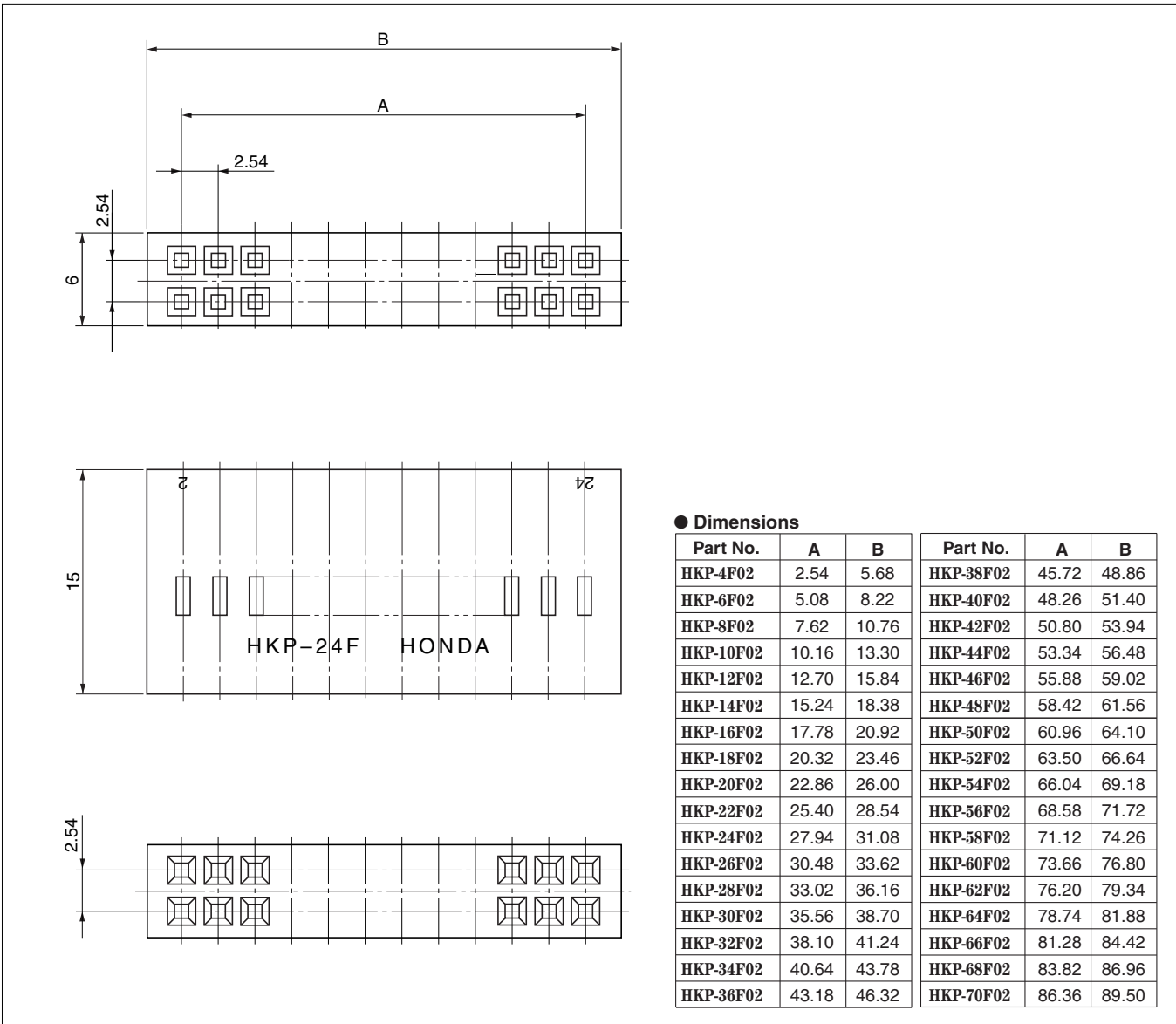

Mating connectors: HKP or FFC series double-row type male connector

For use with contacts: HKP series contacts (HKP-F1@3, HKP-F4@3, HKP-F2@3A, HKP-F3@3A)

Female insulator for crimping(Miniature HKP series)
 HKP-()FSA01

For cable

Crimping

RoHS

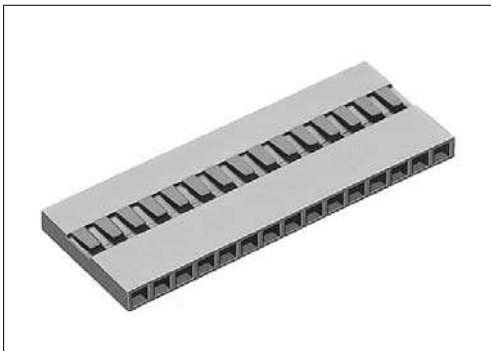

● Configuration of product Part No.

HKP- () F S A01

① ② ③ ④ ⑤

- ① Series name
- ② No. of contacts: 2-50
- ③ Type of insulator
F: Female
- ④ Alignment of contacts to be inserted
S: Single-row type
- ⑤ Type of HKP series
A: Miniature

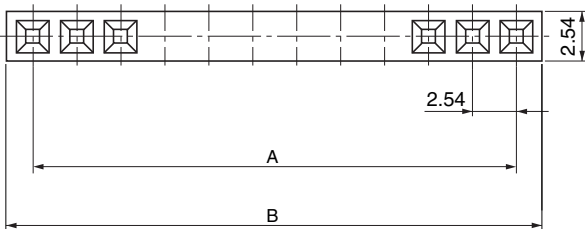
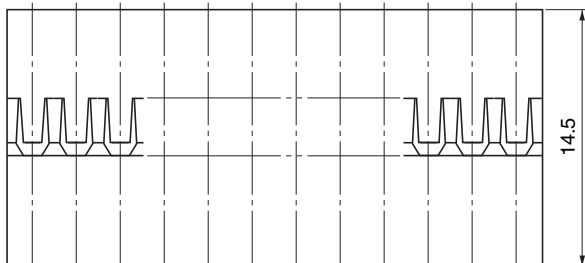

● Dimensions

Part No.	A	B
HKP-2FSA01	2.54	5.08
HKP-3FSA01	5.08	7.62
HKP-4FSA01	7.62	10.16
HKP-5FSA01	10.16	12.70
HKP-6FSA01	12.70	15.24
HKP-7FSA01	15.24	17.78
HKP-8FSA01	17.78	20.32
HKP-9FSA01	20.32	22.86
HKP-10FSA01	22.86	25.40
HKP-11FSA01	25.40	27.94
HKP-12FSA01	27.94	30.48
HKP-13FSA01	30.48	33.02
HKP-14FSA01	33.02	35.56
HKP-15FSA01	35.56	38.10
HKP-16FSA01	38.10	40.64
HKP-17FSA01	40.64	43.18
HKP-18FSA01	43.18	45.72
HKP-19FSA01	45.72	48.26
HKP-20FSA01	48.26	50.80
HKP-21FSA01	50.80	53.34
HKP-22FSA01	53.34	55.88
HKP-23FSA01	55.88	58.42
HKP-24FSA01	58.42	60.96
HKP-25FSA01	60.96	63.50
HKP-26FSA01	63.50	66.04

Part No.	A	B
HKP-27FSA01	66.04	68.58
HKP-28FSA01	68.58	71.12
HKP-29FSA01	71.12	73.66
HKP-30FSA01	73.66	76.20
HKP-31FSA01	76.20	78.74
HKP-32FSA01	78.74	81.28
HKP-33FSA01	81.28	83.82
HKP-34FSA01	83.82	86.36
HKP-35FSA01	86.36	88.90
HKP-36FSA01	88.90	91.44
HKP-37FSA01	91.44	93.98
HKP-38FSA01	93.98	96.52
HKP-39FSA01	96.52	99.06
HKP-40FSA01	99.06	101.60
HKP-41FSA01	101.60	104.14
HKP-42FSA01	104.14	106.68
HKP-43FSA01	106.68	109.22
HKP-44FSA01	109.22	111.76
HKP-45FSA01	111.76	114.30
HKP-46FSA01	114.30	116.84
HKP-47FSA01	116.84	119.38
HKP-48FSA01	119.38	121.92
HKP-49FSA01	121.92	124.46
HKP-50FSA01	124.46	127.00

Mating connectors: HKP or FFC series single-row type male connector

For use with contacts: Miniature HKP series contacts (HKP-F6@3B, HKP-F5@3B, HKP-F7@3B)

Female insulator for crimping (Miniature HKP series)
 HKP-()FA01

For cable

Crimping

RoHS

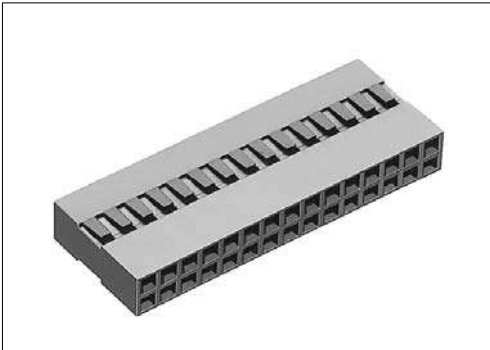

● Configuration of product Part No.

HKP- () F A 01

① ② ③ ④

- ① Series name
- ② No. of contacts: 4-72
- ③ Type of insulator
F: Female
- ④ Type of HKP series
A: Miniature

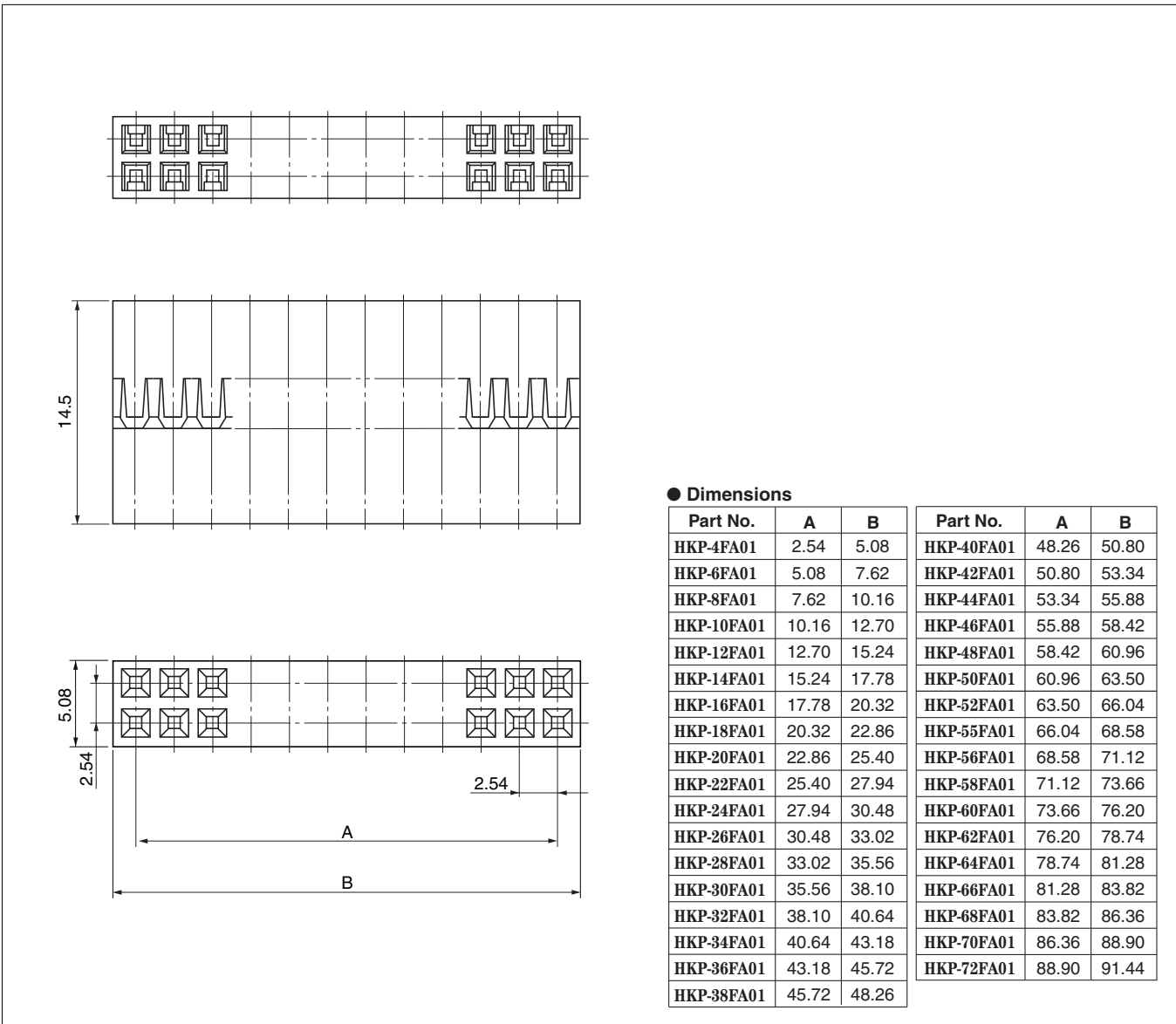

● Dimensions

Part No.	A	B	Part No.	A	B
HKP-4FA01	2.54	5.08	HKP-40FA01	48.26	50.80
HKP-6FA01	5.08	7.62	HKP-42FA01	50.80	53.34
HKP-8FA01	7.62	10.16	HKP-44FA01	53.34	55.88
HKP-10FA01	10.16	12.70	HKP-46FA01	55.88	58.42
HKP-12FA01	12.70	15.24	HKP-48FA01	58.42	60.96
HKP-14FA01	15.24	17.78	HKP-50FA01	60.96	63.50
HKP-16FA01	17.78	20.32	HKP-52FA01	63.50	66.04
HKP-18FA01	20.32	22.86	HKP-55FA01	66.04	68.58
HKP-20FA01	22.86	25.40	HKP-56FA01	68.58	71.12
HKP-22FA01	25.40	27.94	HKP-58FA01	71.12	73.66
HKP-24FA01	27.94	30.48	HKP-60FA01	73.66	76.20
HKP-26FA01	30.48	33.02	HKP-62FA01	76.20	78.74
HKP-28FA01	33.02	35.56	HKP-64FA01	78.74	81.28
HKP-30FA01	35.56	38.10	HKP-66FA01	81.28	83.82
HKP-32FA01	38.10	40.64	HKP-68FA01	83.82	86.36
HKP-34FA01	40.64	43.18	HKP-70FA01	86.36	88.90
HKP-36FA01	43.18	45.72	HKP-72FA01	88.90	91.44
HKP-38FA01	45.72	48.26			

Mating connectors: HKP or FFC series double-row type female connector

For use with contacts: Miniature HKP series contacts (HKP-F6@3B, HKP-F5@3B, HKP-F7@3B)

Cable crimping type female contact for cable HKP-F() ()3(A)

2.54 mm pitch connector

For cable

Crimping

Contacts

RoHS



● Configuration of product Part No.

HKP-F () ()3(A)

① ②

- ① Series name
- ② Type of contact
F: Female

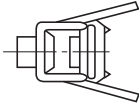

Bulk contact

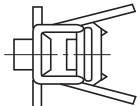

Ribbon type multiple contacts
(1 reel: 10,000 contacts)

Part No.		Cable size	Contact plating
Bulk contact	Ribbon type multiple contacts		
HKP-F113	HKP-F103	AWG#24~28 (ø1.0~1.5mm)	Gold plate
HKP-F413	HKP-F403		Partial gold plate
HKP-F213A	HKP-F203A	AWG#28~32 (ø0.5~0.8mm)	Gold plate
HKP-F313A	HKP-F303A		Partial gold plate

Mating connectors: HKP or FFC series connectors for PCB

Crimping machine: Press body; HTK-211

Applicator: KP-201 for HKP-F103 or HKP-F403, KP-201SA for HKP-F203A or HKP-F303A

Hand crimping tool: KP-309 for HKP-F113 or HKP-F413, KP-309D for HKP-F213A or HKP-F313A (Refer to page Tool-6, 7)

Cable crimping type female contact for cable
(Miniature HKP series)
HKP-F () () 3B

2.54 mm pitch connector

Crimping for cable

Contacts

Miniature HKP series

RoHS



● Configuration of product Part No.

HKP-F () () 3B

① ②

- ① Series name
- ② Type of contact
F: Female

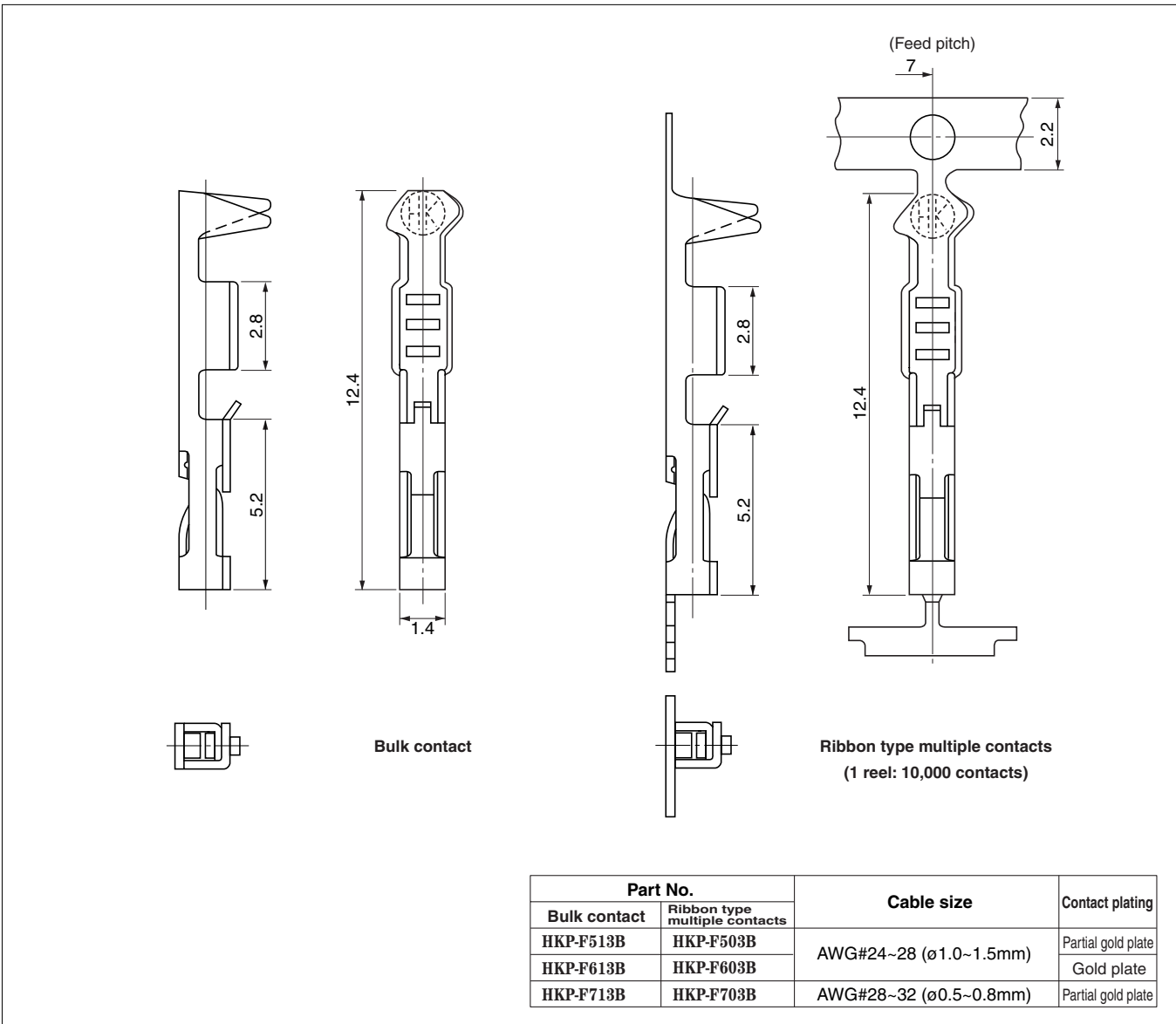

Mating connectors: HKP or FFC series connectors for PCB

Crimping machine: Press body: HTK-211

Applicator: KP-214 for HKP-F503B or HKP-F603B, KP-214SA for HKP-F703B

Hand crimping tool: KP-325 for F513B or HKP-F613B, KP-325D or HKP-F713B (Refer to page Tool-7)

Straight through hole type female connector for PCB HKP-()FDS2

For PCB

Straight Through hole

RoHS

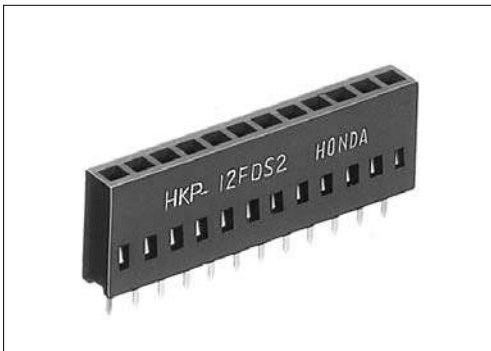

● Configuration of product Part No.

HKP- () FD S 2

① ② ③ ④

- ① Series name
- ② No. of contacts: 2–50
- ③ Type of contact
FD: Straight through hole type, female
- ④ Contact alignment
S: Single-row type

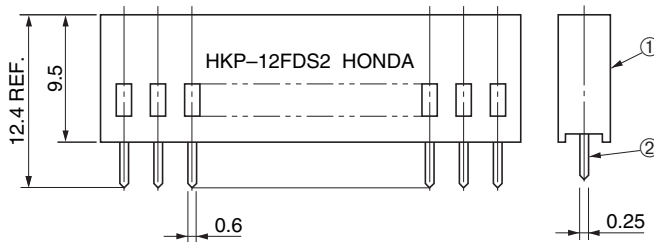
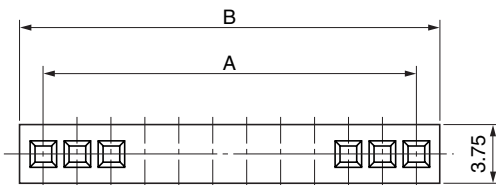

● Dimensions

Part No.	A	B	Part No.	A	B
HKP-2FDS2	2.54	5.68	HKP-27FDS2	66.04	69.18
HKP-3FDS2	5.08	8.22	HKP-28FDS2	68.58	71.72
HKP-4FDS2	7.62	10.76	HKP-29FDS2	71.72	74.26
HKP-5FDS2	10.16	13.30	HKP-30FDS2	73.66	76.80
HKP-6FDS2	12.70	15.84	HKP-31FDS2	76.20	79.34
HKP-7FDS2	15.24	18.38	HKP-32FDS2	78.74	81.88
HKP-8FDS2	17.78	20.92	HKP-33FDS2	81.28	84.42
HKP-9FDS2	20.32	23.46	HKP-34FDS2	83.82	86.96
HKP-10FDS2	22.86	26.00	HKP-35FDS2	86.36	89.50
HKP-11FDS2	25.40	28.54	HKP-36FDS2	88.90	92.04
HKP-12FDS2	27.94	31.08	HKP-37FDS2	91.44	94.58
HKP-13FDS2	30.48	33.62	HKP-38FDS2	93.98	97.12
HKP-14FDS2	33.02	36.16	HKP-39FDS2	96.52	99.66
HKP-15FDS2	35.56	38.70	HKP-40FDS2	99.06	102.20
HKP-16FDS2	38.10	41.24	HKP-41FDS2	101.60	104.74
HKP-17FDS2	40.64	43.78	HKP-42FDS2	104.14	107.28
HKP-18FDS2	43.18	46.32	HKP-43FDS2	106.68	109.82
HKP-19FDS2	45.72	48.86	HKP-44FDS2	109.22	112.36
HKP-20FDS2	48.26	51.40	HKP-45FDS2	111.76	114.90
HKP-21FDS2	50.80	53.94	HKP-46FDS2	114.30	117.44
HKP-22FDS2	53.34	56.48	HKP-47FDS2	116.84	119.98
HKP-23FDS2	55.88	59.02	HKP-48FDS2	119.38	122.52
HKP-24FDS2	58.42	61.56	HKP-49FDS2	121.92	125.06
HKP-25FDS2	60.96	64.10	HKP-50FDS2	124.46	127.60
HKP-26FDS2	63.50	66.64			

● Components

①	Insulator
②	Contact

Mating connector: HKP or FFC series single-row type male connector

Straight through hole type female connector for PCB HKP-()FD2

2.54 mm pitch connector

For PCB

Straight Through hole

RoHS

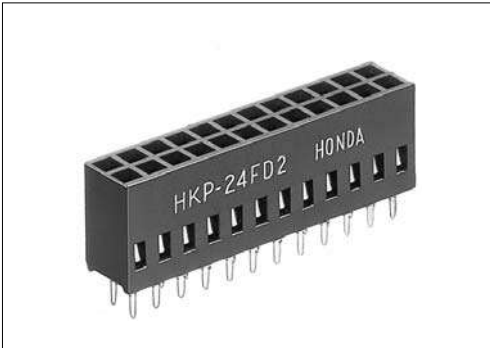

● Configuration of product Part No.

HKP- () FD 2

① ② ③

- ① Series name
- ② No. of contacts: 4-70
- ③ Type of contact
FD: Straight through hole type, female double-rows

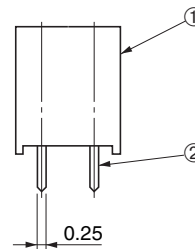
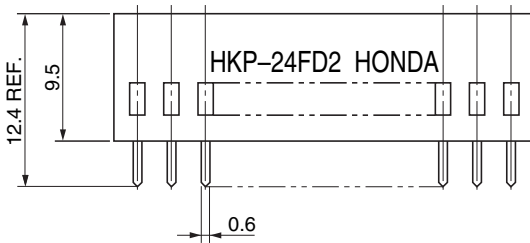
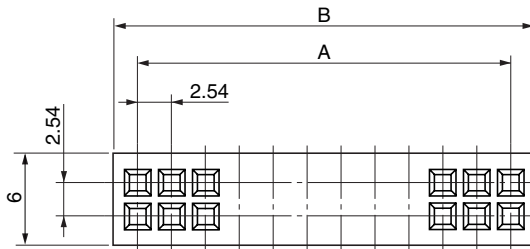

● Dimensions

Part No.	A	B
HKP-4FD2	2.54	5.68
HKP-6FD2	5.08	8.22
HKP-8FD2	7.62	10.76
HKP-10FD2	10.16	13.30
HKP-12FD2	12.70	15.84
HKP-14FD2	15.24	18.38
HKP-16FD2	17.78	20.92
HKP-18FD2	20.32	23.46
HKP-20FD2	22.86	26.00
HKP-22FD2	25.40	28.54
HKP-24FD2	27.94	31.08
HKP-26FD2	30.48	33.62
HKP-28FD2	33.02	36.16
HKP-30FD2	35.56	38.70
HKP-32FD2	38.10	41.24
HKP-34FD2	40.64	43.78
HKP-36FD2	43.18	46.32
HKP-38FD2	45.72	48.86
HKP-40FD2	48.26	51.40
HKP-42FD2	50.80	53.94
HKP-44FD2	53.34	56.48
HKP-46FD2	55.88	59.02
HKP-48FD2	58.42	61.56
HKP-50FD2	60.96	64.10
HKP-52FD2	63.50	66.64
HKP-54FD2	66.04	69.18
HKP-56FD2	68.58	71.72
HKP-58FD2	71.12	74.26
HKP-60FD2	73.66	76.80
HKP-62FD2	76.20	79.34
HKP-64FD2	78.74	81.88
HKP-66FD2	81.28	84.42
HKP-68FD2	83.82	86.96
HKP-70FD2	86.36	89.50

● Components

①	Insulator
②	Contact

Mating connectors: HKP or FFC series double-row type male connector

Straight SMT type female connector for PCB
HKP-S()FD+

For PCB

Straight SMT

RoHS

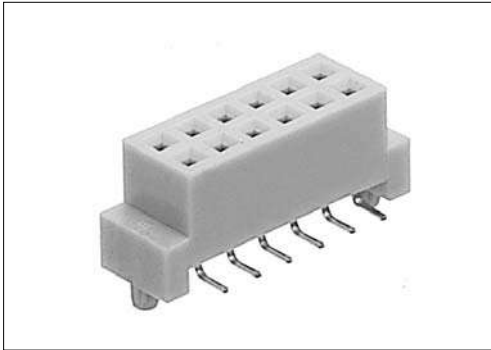

● Configuration of product Part No.

HKP- S () FD+

① ② ③ ④

- ① Series name
- ② S: SMT type
- ③ No. of contacts: 12 or 44
- ④ Type of contact
FD: Straight, female

Top view dimensions: A, B, 2.54, 0.5, 2.54, 6.04, 9 REF.

Recommended PCB layout dimensions: C, B, 2.54, 0.8, 5.3, 9.8, ø2(Holes)

Side view dimensions: D, 7.9, 1.6, ø2.14, C

Cross-section dimensions: 0.25, ①, ②

● Components

①	Insulator
②	Contact

● Dimensions

Part No.	A	B	C	D
HKP-S12FD+	19.63	12.7	17.78	15.84
HKP-S44FD+	60.27	53.34	58.42	56.48

Mating connectors: HKP or FFC series double-row type male connector

Misinsertion prevention key / Extraction tool

2.54 mm pitch connector



Accessories

Misinsertion prevention key

Extraction tool

RoHS

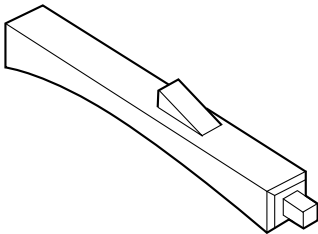
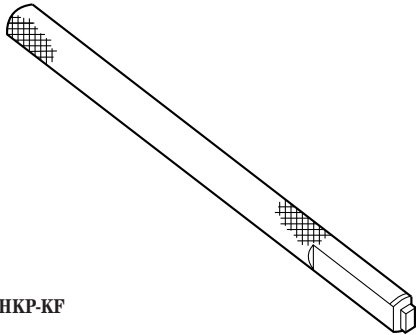
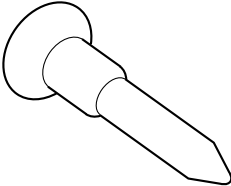
- ① Misinsertion prevention key
 - HKP-44F201: For HKP-()FS01 or HKP-()FA02
 - HKP-72FA02: For HKP-()FD2 or HKP-()FD2
 - GM-25K : For HKP-()FSA01 or HKP-()FA01
- ② Extraction tool
 - HKP-KF : For HKP-()FS01 or HKP-()F02
 - HKP-RF : For HKP-()FSA01 or HKP-()FA01

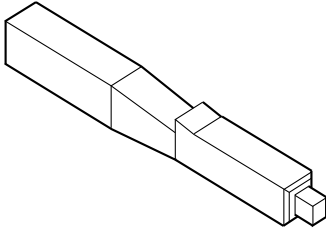
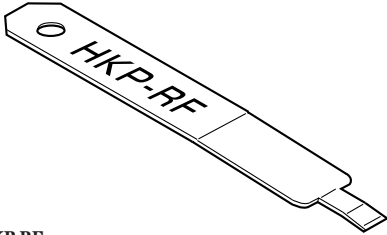
Connector	Misinsertion prevention key	Extraction tool
<p style="text-align: center;">HKP series</p>	 <p style="text-align: center;">HKP-44F201</p>	 <p style="text-align: center;">HKP-KF</p>
	 <p style="text-align: center;">GM-25K</p>	
<p style="text-align: center;">Miniature HKP series</p>	 <p style="text-align: center;">HKP-72FA02</p>	 <p style="text-align: center;">HKP-RF</p>